

***Aspire 2010***  
***Aspire 2020***  
***Service Guide***

Service guide files and updates are available on the ACER/CSD web; for more information, please refer to <http://csd.acer.com.tw>

PRINTED IN TAIWAN

**NOTE:** This is Aspire 2000 extension model. Please refer to Aspire 2000 Service CD(**P/N: VD.A20V5.001**) for the disassemble mpeg file.

---

## ***Revision History***

Please refer to the table below for the updates made on Aspire 2010/2020 service guide.

<b>Date</b>	<b>Chapter</b>	<b>Updates</b>

---

## **Copyright**

Copyright © 2004 by Acer Incorporated. All rights reserved. No part of this publication may be reproduced, transmitted, transcribed, stored in a retrieval system, or translated into any language or computer language, in any form or by any means, electronic, mechanical, magnetic, optical, chemical, manual or otherwise, without the prior written permission of Acer Incorporated.

## **Disclaimer**

The information in this guide is subject to change without notice.

Acer Incorporated makes no representations or warranties, either expressed or implied, with respect to the contents hereof and specifically disclaims any warranties of merchantability or fitness for any particular purpose. Any Acer Incorporated software described in this manual is sold or licensed "as is". Should the programs prove defective following their purchase, the buyer (and not Acer Incorporated, its distributor, or its dealer) assumes the entire cost of all necessary servicing, repair, and any incidental or consequential damages resulting from any defect in the software.

Acer is a registered trademark of Acer Corporation.

Intel is a registered trademark of Intel Corporation.

Pentium and Pentium II/III are trademarks of Intel Corporation.

Other brand and product names are trademarks and/or registered trademarks of their respective holders.

---

## ***Conventions***

The following conventions are used in this manual:

<b>SCREEN MESSAGES</b>	Denotes actual messages that appear on screen.
<b>NOTE</b>	Gives bits and pieces of additional information related to the current topic.
<b>WARNING</b>	Alerts you to any damage that might result from doing or not doing specific actions.
<b>CAUTION</b>	Gives precautionary measures to avoid possible hardware or software problems.
<b>IMPORTANT</b>	Reminds you to do specific actions relevant to the accomplishment of procedures.

---

## ***Preface***

Before using this information and the product it supports, please read the following general information.

1. This Service Guide provides you with all technical information relating to the BASIC CONFIGURATION decided for Acer's "global" product offering. To better fit local market requirements and enhance product competitiveness, your regional office MAY have decided to extend the functionality of a machine (e.g. add-on card, modem, or extra memory capability). These LOCALIZED FEATURES will NOT be covered in this generic service guide. In such cases, please contact your regional offices or the responsible personnel/channel to provide you with further technical details.
2. Please note WHEN ORDERING FRU PARTS, that you should check the most up-to-date information available on your regional web or channel. If, for whatever reason, a part number change is made, it will not be noted in the printed Service Guide. For ACER-AUTHORIZED SERVICE PROVIDERS, your Acer office may have a DIFFERENT part number code to those given in the FRU list of this printed Service Guide. You MUST use the list provided by your regional Acer office to order FRU parts for repair and service of customer machines.

## **Chapter 1 System Specifications 1**

Features .....	1
System Block Diagram .....	4
Board Layout .....	5
Top View .....	5
Rear View .....	5
Outlook View .....	7
Aspire 2010 Open View .....	7
Aspire 2010 Front Panel .....	8
Aspire 2010 Top Panel .....	9
Aspire 2010 Left Panel .....	10
Aspire 2010 Right Panel .....	11
Aspire 2010 Rear Panel .....	12
Aspire 2010 Bottom View .....	13
Aspire 2020 Open View .....	14
Aspire 2020 Front View .....	15
Aspire 2020 Top View .....	16
Aspire 2020 Left View .....	17
Aspire 2020 Right View .....	18
Aspire 2020 Rear View .....	19
Aspire 2020 Bottom View .....	20
Indicators .....	21
Keyboard .....	23
Embedded Numeric Keypad .....	24
Hot Keys .....	25
Windows Keys .....	28
The Euro Symbol .....	29
Touchpad .....	30
Launch Keys .....	32
Hardware Specifications and Configurations .....	33

## **Chapter 2 System Utilities 42**

BIOS Setup Utility .....	42
Navigating the BIOS Setup Utility .....	42
Main .....	45
Advanced .....	48
Security .....	51
Boot .....	53
Exit .....	54
BIOS Flash Utility .....	57

## **Chapter 3 Machine Disassembly and Replacement 58**

General Information .....	59
Before You Begin .....	59
Disassembly Procedure Flowchart .....	60
Disassemble the Battery and HDD .....	62
Disassemble the Wireless .....	62
Disassemble the RAM and ODD .....	62
Disassemble the Middle Cover Board .....	63
Disassemble the Keyboard .....	63
Disassemble the LCD .....	64
Disassemble the MDC and RAM .....	64
Disassemble the Upper Case .....	64

# Table of Contents

Disassemble the Main Unit(Touchpad, Bluetooth and LCM Board) . . . . .	65
Disassemble the Main Unit(Speakers, Fan, Thermal and CPU) . . . . .	66
Disassemble the Main Unit(VGA, Card Reader, Sub-Woofer and M/B) . . . . .	67
Disassemble the LCD Module . . . . .	68
Disassemble the ODD Module . . . . .	69
Disassemble the HDD Module . . . . .	69

## **Chapter 4 Troubleshooting 70**

System Check Procedures . . . . .	71
External Diskette Drive Check . . . . .	71
External CD-ROM/DVD ROM Drive Check . . . . .	71
Keyboard or Auxiliary Input Device Check . . . . .	72
Memory Check . . . . .	72
Power System Check . . . . .	72
Check the Power Adapter . . . . .	73
Check the Battery Pack . . . . .	74
Touchpad Check . . . . .	74
Display Check . . . . .	74
Sound Check . . . . .	75
Insyde MobilePro BIOS POST Beep code and POST Messages . . . . .	76
Index of Symptom-to-FRU Error Message . . . . .	78
Intermittent Problems . . . . .	82
Undetermined Problems . . . . .	83
How to Build NAPP Master Hard Disc Drive . . . . .	84
CD to Disk Recovery . . . . .	84
Disk to Disk Recovery . . . . .	87

## **Chapter 5 Jumper and Connector Locations 91**

Top View . . . . .	91
Bottom View . . . . .	93
Power Board . . . . .	94
TouchPad Board . . . . .	95
SD Board . . . . .	97
Media Board . . . . .	98
LED Board . . . . .	99
Bottom Board . . . . .	100

## **Chapter 6 FRU (Field Replaceable Unit) List 101**

Exploded Diagram . . . . .	102
Aspire 2010 Parts List . . . . .	103
Aspire 2020 Parts List . . . . .	109

## **Appendix A Model Definition and Configuration 113**

## **Appendix B Test Compatible Components 114**

Microsoft Windows XP Home Environment Test . . . . .	115
Microsoft Windows XP Professional Environment Test . . . . .	118

## **Appendix C Online Support Information 121**

# System Specifications

## Features

This computer was designed with the user in mind. Here are just a few of its many features:

### Performance

- Intel® Pentium M processor at 1.4~ 1.8 GHz or higher with uPGA478 socket
- Intel 855GME + Intel ICH4-M
- 1MB L2 cache or 2MB L2 cache, 400MHz FSB, supporting Enhanced Intel SpeedStep® technology
- 30GB and up Enhanced-IDE hard disk drive
- 512KB Flash BIOS ROM

### Memory

- 256MB of DDR333 memory, upgradeable to 2GB with dual SODIMM modules
- 0MB DDR RAM on board
- Two 256MB of DDR333 SODIMM (200-pin/2.5V/1.25V) connector, upgradeable to 2GB with dual SODIMM modules

**NOTE:** (Small Outline-DIMM) A DIMM module with a thinner profile due to the use of TSOP chip packages. SODIMMs are commonly used in laptop computers

The pic of SODIMM as showing : (copyright from Techweb)



### Display

- Thin-Film Transistor (TFT) liquid-crystal display (LCD) displaying 32-bit high true colour up to 16.7 million colours at 1280x800 eXtended Graphics Array (WXGA) resolution
- The 15.4" display panel provides a large viewing area for maximum efficiency and ease-of-use
- 16:10 viewing ratio, 185 nits or higher
- Console display for Arcade media playback status
- Intel® Extreme Graphics Technology (for Aspire 2010 use only)
- ATI Radeon 9700 with 64MB DDR VGA Memory (for model with Discrete VGA only)
- ATI Radeon 9700 with 128MB DDR VGA Memory (for model with Aspire 2020 only)
- Supports simultaneous display on external LCD or CRT
- One LED console display for multimedia status (for Aspire 2020 only)
- S-video for output to a television or display device that supports S-video input
- DualView™ support
- External resolution/refresh rate
  - 2040x1536:75/70/66/60 Hz
  - 1920x1440: 85/75/60 Hz



- 
- 1920x1200: 100/85/80/75/72/60 Hz
  - 1600x1200: 120/100/92/85/76/75/72/70/66/65/60/58/52 Hz
  - 1280x1024: 160/120/100/90/85/75/74/72/70/60 Hz
  - 1280x768: 85/75/60/56 Hz
  - 1024x768: 200/160/150/140/120/100/90/85/75/72/70/60 Hz
  - 800x600: 200/160/140/120/100/90/85/75/72/70/60/56 Hz

### ***Multimedia***

- Built-in optical drive (Tray loading DVD/CD-RW Combo or DVD Super-Mult Drive **Aspire 2010** only)
- Built-in optical drive (Slot-loading DVD/CD-RW Combo or DVD Super-Multi or Tray-loading DVD Dual Drive **Aspire 2020** only)
- 15.4" TFT Color LCD, 1280x800 (WXGA) panel
- 2.1 channel speaker
- Audio input and output jacks
- Audio S/PDIF (for digital audio enjoyment) output jacks (for **Aspire 2020** only)
- Aspire virtual surround sound ( for **Aspire 2010** only)
- Aspire virtual surround sound with built-in sub-woofer (for **Aspire 2020** only)

### ***Storage***

- 30/40/60/80 GB ATA/100 hard disc drive
- 4-in-1 card reader, supporting :
  - MultiMedia Card (MMC)
  - Secure Digital (SD)
  - SmartMedia
  - Memory Stick (For module with Discrete VGA only)

### ***Connectivity***

- Integrated 10/100Mbps Ethernet Connection
- Built-in 56Kbps fax /data modem with international PTT approval, Wake-On-Ring ready
- Three universal serial bus (USB 2.0) ports
- One IEEE 1394 port
- LAN: 10/100 Mbps Fast Ethernet; Wake-on-LAN ready (for **Aspire 2010** only)  
10/100/1000 Mbps Fast Ethernet; Wake-on-LAN ready (for **Aspire 2020** only)
- 802.11b and 802.11b/g Wireless LAN and Bluetooth

### ***Human-Centric Design***

- Rugged, portable construction
- Stylish appearance
- Standard 85 key keyboard with four programmable launch keys
- Comfortable palm rest area with well-positioned touchpad

---

## **Graphics**

- Intel® 855GME integrated 3D AGP graphics featuring Intel® Extreme Graphics 2 technology and up to 64MB of video memory (for model with UMA only)
- ATI Radeon 9700 with 64MB DDR VGA Memory (for model with Discrete VGA only)
- ATI MOBILITY™ RADEON™ 9700 with 128MB of external DDR video RAM, supporting Microsoft® DirectX® 9.0 (for **Aspire 2020** only)
- Simultaneous LCD and CRT display at 2040x1536 pixel resolution
- DuralView™ support
- Aspire cinema vision video encoded technology
- Aspire clear vision video input optimisation technology
- MPEG-2 DVD hardware-assisted capability
- S-Video/TV-out support (NTSC/PAL)

## **Expansion**

- PC card slot enables a range of add-on options
- Upgradeable hard disk and memory modules

## **I/O Ports**

- Three USB 2.0 ports
- IEEE 1394 port
- Ethernet (RJ-45) port
- Modem (RJ-11) port
- S-video TV-Out (NTSC/PAL) port
- Parallel port
- External display (VGA) port
- Microphone/Line-in Jack
- Headphone/Speaker/Line-out Jack (**S/PDIF support for Aspire 2020 only**)
- Infrared (FIR) port
- PC Card slot (one type II, supports 16-bit PCMCIA and 32-bit CardBus specifications)
- DC-in Jack for AC adapter

# System Block Diagram

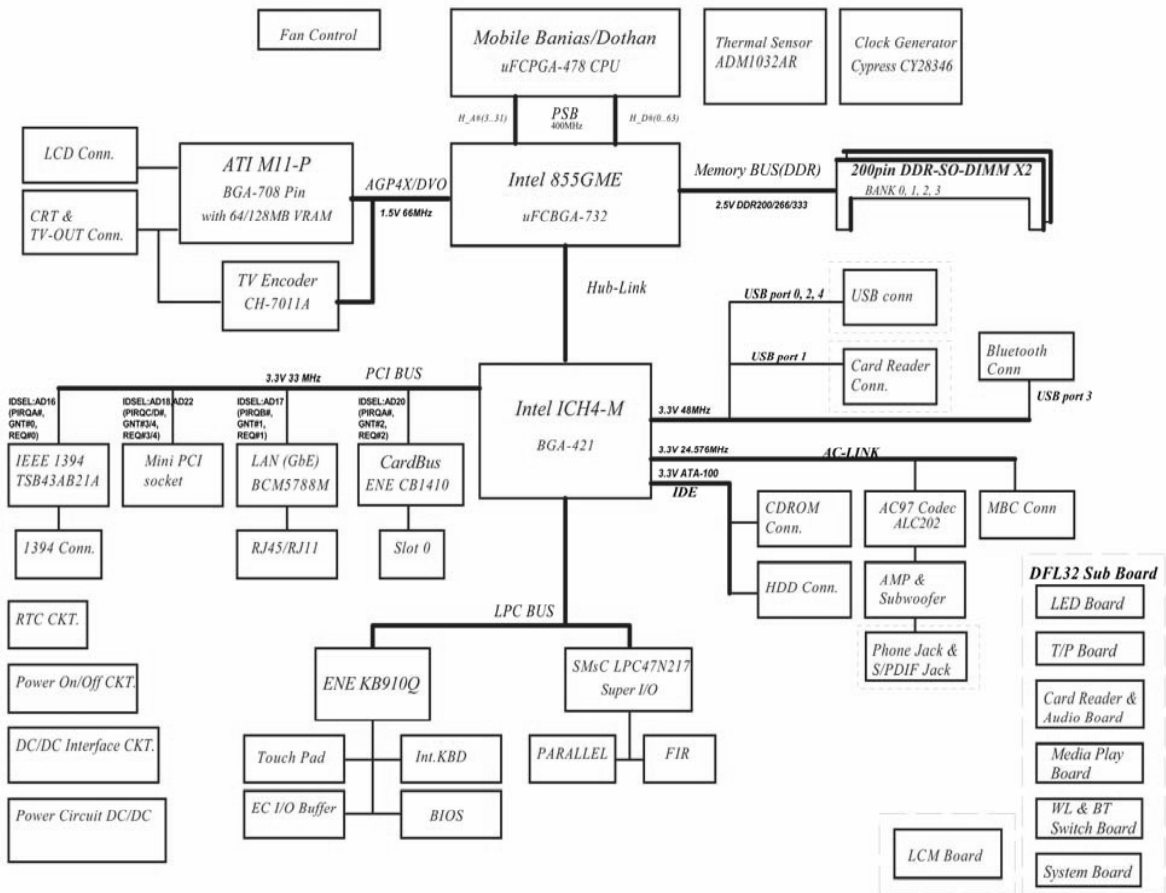

# Board Layout

## Top View

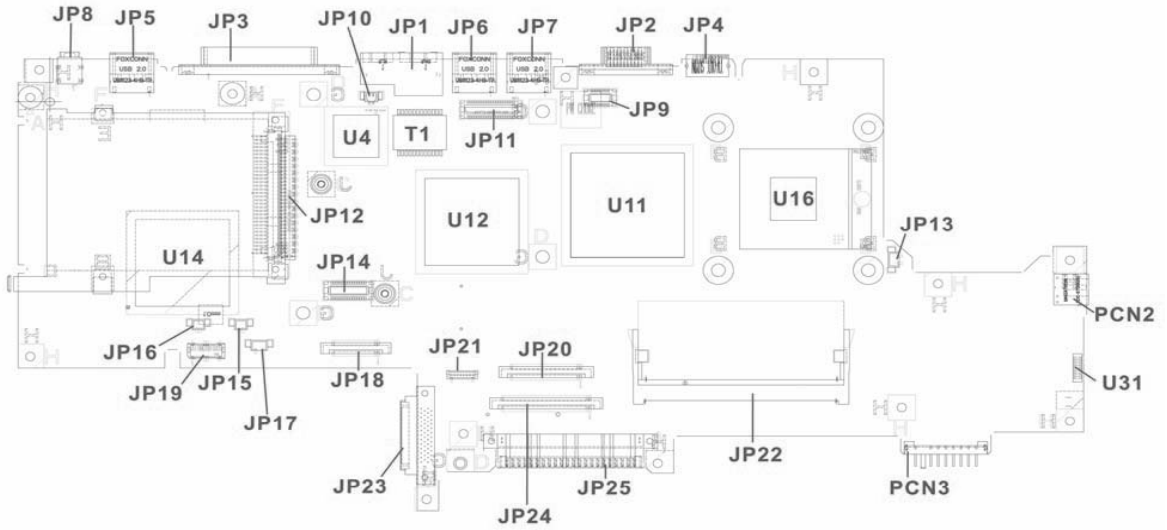

## Rear View

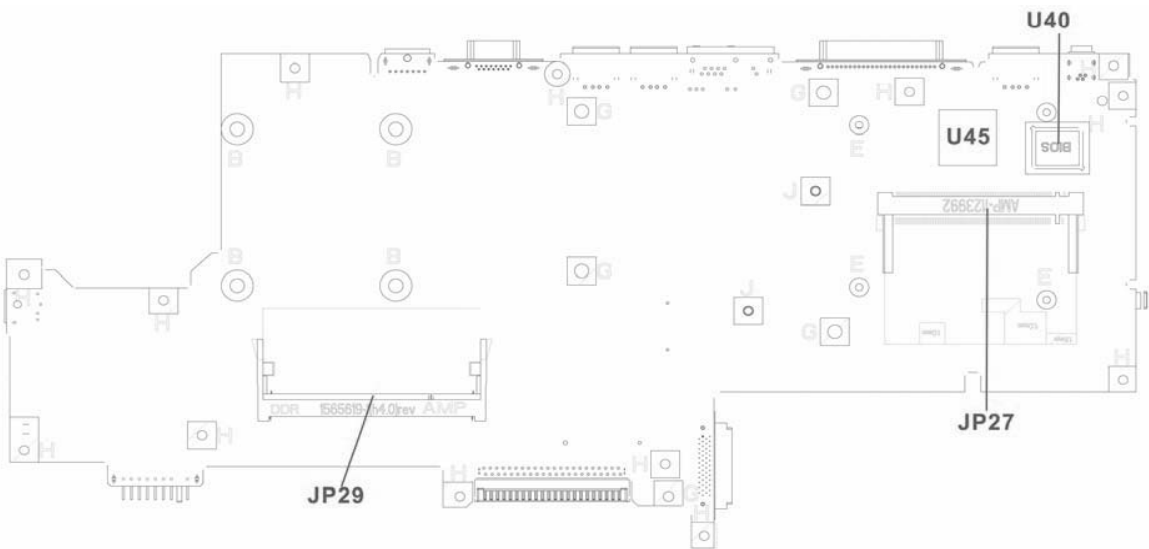

Item	Description	Item	Description
JP1	RJ11/RJ45 Connector	JP20	Int. K/B Connector
JP2	CRT Connector	JP21	Bluetooth Connector
JP3	Printer Connector	JP22	DDR SODIMM Socket
JP4	TV-Out Connector	JP23	ODD Connector
JP5	USB Connector	JP24	T/P Board Connector
JP6	USB Connector	JP25	HDD Connector
JP7	USB Connector	JP27	MINIPCI Connector
JP8	IEEE 1394 Connector	JP29	DDR SODIMM Socket
JP9	Power Board Connector	PCN2	AC Jack Connector
JP10	MDC Cable Connector	PCN3	Battery Connector
JP11	LCD Connector	U4	LAN Chip
JP12	Cardbus Connector	U11	North Bridge Chip
JP13	FAN Connector	U12	VGA Chip
JP14	MDC Connector	U14	South Bridge Chip
JP15	Right Speaker Connector	U16	CPU Socket
JP16	Left Speaker Connector	U31	FIR
JP17	Subwoofer Connector	U40	BIOS ROM
JP18	LCM Connector	U45	Cardbus Controller
JP19	SD Board Connector	T1	LAN Transformer

---

## Outlook View

A general introduction of ports allow you to connect peripheral devices, as you would with a desktop PC.





### Aspire 2010 Open View



#	Item	Description
1	Screen	Wide screen display provides visual output.
2	Power Button	Turns the computer on or off
3	Launch Keys	Buttons that can be programmed to start frequently used applications.
4	Stereo Speakers	Produce stereo sound
5	Touchpad	Touch sensitive pad that functions like a computer mouse.
6	Click buttons and 4-way scroll key	Right and left buttons that provide the same functions as the buttons on a computer mouse. The scroll key scrolls the contents of a window up and down, as well as right and left.

## Aspire 2010 Front Panel



#	Icon	Item	Description
1		Headphone-in Jack	Connects headphones for audio output.
2		Microphone-in Jack	Connects an external microphone for audio input
3		4 in 1 Card Reader	Supports: <ul style="list-style-type: none"> <li><input type="checkbox"/> Memory Stick</li> <li><input type="checkbox"/> MultiMediaCard</li> <li><input type="checkbox"/> SecureDigital</li> <li><input type="checkbox"/> SmartMedia</li> </ul>
4		Latch	Locks and releases the lid
5		Bluetooth Button	Starts Bluetooth functionality
6		Wireless Button	Turns an internal wireless device on or off

---

## *Aspire 2010 Top Panel*



#	Item	Description
1	Built-in Microphone	For recording audio on the computer
2	Status Indicator	LEDs that turn on and off to show the system status



---

## Aspire 2010 Left Panel



#	Item	Description
1	PC Card Slot	Type II PC card slot, supports PCMCIA or CardBus
2	PC card eject button	Press the eject button to remove a PC card from the PC card slot
3	LED Indicator	Lights up when the optical drive in active
4	Eject Button	Ejects optical drive tray
5	Emergency eject hole	Ejects optical drive tray when the computer is turned off.

---







## Aspire 2010 Right Panel

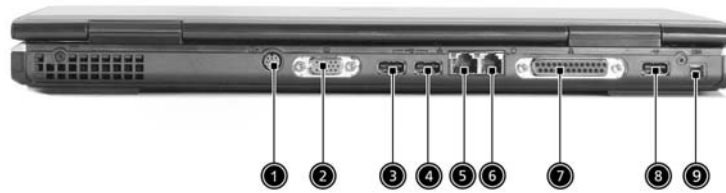

#	Item	Description
1	Infrared Port	Interfaces with infrared devices (e.g., infrared printer, IR-aware computer)
2	DC-in Jack	Connect the AC adapter
3	Kensington lock slot	For attaching a security connector.
4	Ventilation Hole	Enables the computer to stay cool, even after prolonged use.

## Aspire 2010 Rear Panel



#	Icon	Item	Description
1		S-Video	Connects to a television or display device with S-video input.
2		External display port	Connects an external (VGA) display monitor.
3,4,8		USB Ports	Three USB2.0 ports for connecting USB devices.
5		Network Jack	Connects the computer to an Ethernet 10/100-based network.
6		Modem Jack	Connects the built-in fax/data modem to a phone line.
7		Parallel Port	Connects a parallel device, such as a printer.
9		IEEE 1394 Port	Connects IEEE 1394 devices.

## Aspire 2010 Bottom View

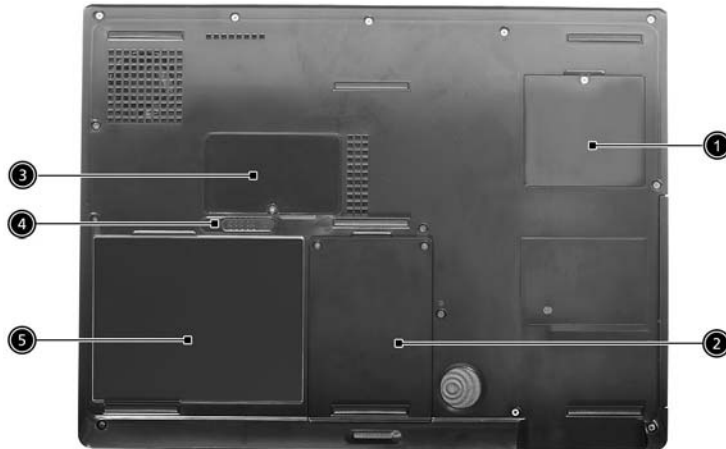

#	Item	Description
1	Mini-PCI Slot	Slot for adding mini-PCI cards
2	Hard Disk Bay	Removable cover provides access to the computer's hard drive.
3	Memory Compartment	Removable cover provides access to the memory slots for upgrading the computer's memory.
4	Battery Release Latch	Unlatches the battery to remove the battery pack
5	Battery Pack	The computer's removable battery



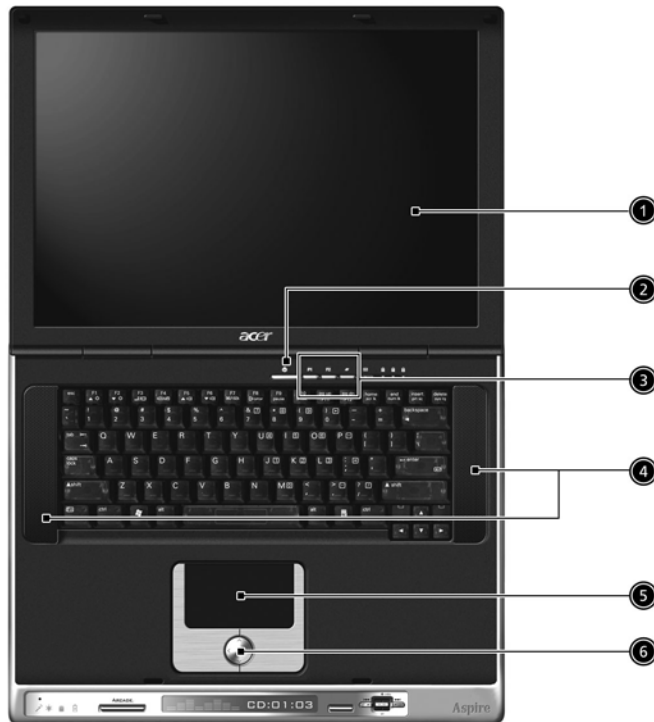

## Aspire 2020 Open View

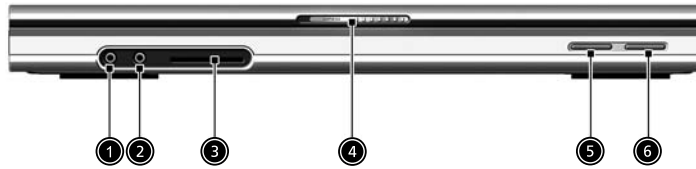

#	Item	Description
1	Screen	Wide screen display provides visual output
2	Power Button	Turns the computer on or off
3	Launch Keys	Buttons that can be programmed to start frequently used applications
4	Stereo Speakers	Produce stereo sound
5	Touchpad	Touch sensitive pad that functions like a computer mouse
6	Click buttons and 4-way scroll key	Right and left button that provide the same functions as the buttons on a computer mouse. The scroll key scrolls the contents of a window up and down, as well as right and left

## Aspire 2020 Front View



#	Icon	Item	Description
1		Headphone-in Jack	Connects headphones for audio output
2		Microphone-in Jack	Connects an external microphone for audio input
3		4 in 1 Card Reader	Supports: <ul style="list-style-type: none"> <li><input type="checkbox"/> MemoryStick</li> <li><input type="checkbox"/> MultitMediaCard</li> <li><input type="checkbox"/> SecureDigital</li> <li><input type="checkbox"/> SmartMedia</li> </ul>
4		Latch	Locks and release the lid
5		Bluetooth Button	Enables Bluetooth functionality (manufacturing option)
6		Wireless Button	Enables Wireless Connectivity (manufacturing option)

## Aspire 2020 Top View



#	Item	Description
1	Built-In Microphone	For recording audio on the computer
2	Status Indicator	LEDs that turn on and off to show system status
3	Arcade Button	Multimedia button
4	Console display	Media status display
5	Stop	Stop the Arcade application
6	Media Controls	Multimedia Button

---

## Asipre 2020 Left View

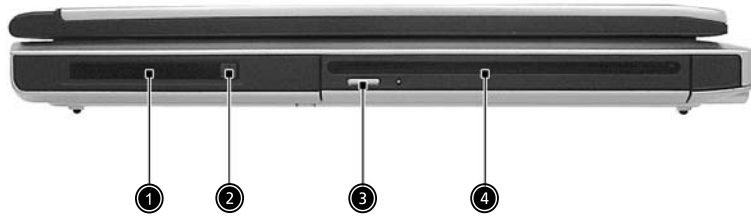

#	Item	Description
1	PC card slot	Type II PC card supports PCMCIA or CardBus
2	PC card eject button	Press the eject button to remove a PC card from the PC card slot
3	Eject button	Ejects optical disc
4	Slot-loading Optical	Support an optical disc





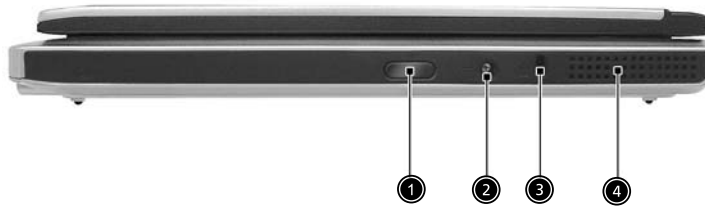



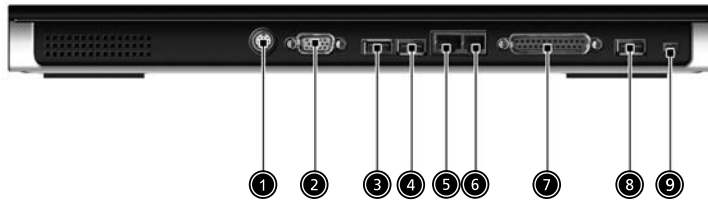

## Aspire 2020 Right View



#	Item	Description
1	Infrared Port	Interfaces with infrared devices(e.g. infrared printer, IR. aware computer, etc..)
2	DC-in Jack	Connect the AC power adapter
3	Kensington lock slot	For attaching a security device
4	Ventilation slot	Enables the computer to stay cool, even after prolonged use

## Aspire 2020 Rear View



#	Icon	Item	Description
1		S-Video	Connects to a television or display device with S-video input.
2		External display port	Connects an external (VGA) display monitor.
3,4,8		USB Ports	Three USB2.0 ports for connecting USB devices.
5		Network Jack	Connects the computer to an Ethernet 10/100-based network.
6		Modem Jack	Connects the built-in fax/data modem to a phone line.
7		Parallel Port	Connects a parallel device, such as a printer.
9		IEEE 1394 Port	Connects IEEE 1394 devices.

## Aspire 2020 Bottom View

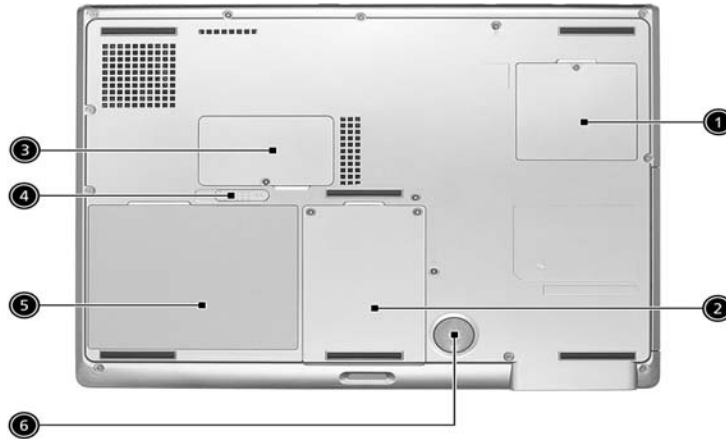

#	Item	Description
1	Mini-PCI Slot	Slot for adding mini-PCI slot
2	Hard Disk Bay	Removable cover provides access to the computer's hard disk drive
3	Memory Compartment	Removable cover provides access to the memory slots for upgrading the computer's memory
4	Battery Release Latch	Unlatches the battery to remove the battery pack
5	Battery Pack	The computer's removable battery
6	Sub-Woofer	Outputs low/mid range audio

---

# Indicators

Your computer provides an array of three indicators located above the keyboard, in addition to four indicators positioned at the front of the palm rest area. These indicators show the status of the computer and its components.









The three indicators located above the keyboard provide the following status information:

Icon	Description
	Caps Lock activity Blue -- Capital lock is on
	Num Lock activity Blue -- Number lock is on
	Scroll Lock activity

**NOTE:** The keypad lock must be turned on to use the embedded numeric keypad.

The four indicators located at the front of the unit provide the following status information:

Icon	Item	Description
	Power mode	<input type="checkbox"/> Off --System Off <input type="checkbox"/> Green -- System On <input type="checkbox"/> Orange -- System in standby mode (S3 state) <input type="checkbox"/> Orange Flashing --System Entering hibernation mode (S4 state) until process complete <input type="checkbox"/> Readable when LCD lid closed
	Media Activity	<input type="checkbox"/> Flashing --Media is active <input type="checkbox"/> Media includes all internal media devices, such as HDD and ODD.
	Email	<input type="checkbox"/> Flash when receiving mails
	Hard Disc mode	<input type="checkbox"/> Hard disc drive is reading or writing data
	Battery mode	<input type="checkbox"/> Blue -- fully charged <input type="checkbox"/> Flashing orange -- Low power <input type="checkbox"/> Orange -- Charging <input type="checkbox"/> Readable when LCD lid closed
	Bluetooth mode	<input type="checkbox"/> Bluetooth wireless connection is enabled <input type="checkbox"/> Blue -- Internal Bluetooth is on <input type="checkbox"/> Readable when LCD lid closed
	Wireless LAN mode	<input type="checkbox"/> Wireless LAN communication is enabled <input type="checkbox"/> Orange -- Internal WLAN device (802.11a/802.11b/802.11g) is on <input type="checkbox"/> Readable when LCD lid closed

---

# Keyboard

The keyboard features full-size keys with an embedded keypad, separated cursor keys, two Windows keys, and twelve function keys (hot keys).

## Special keys

### Lock keys

#### Aspire 2010

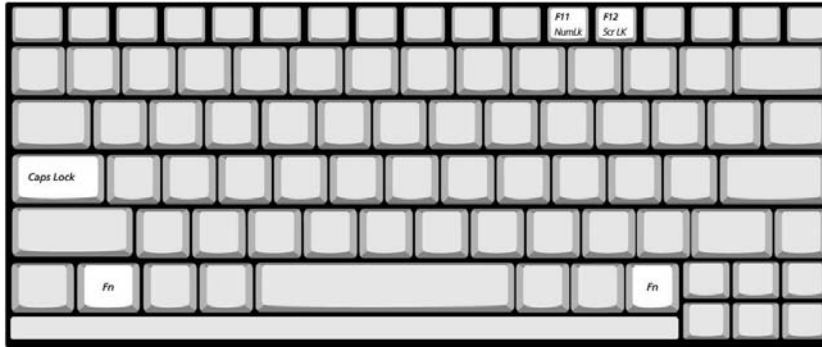

#### Aspire 2020

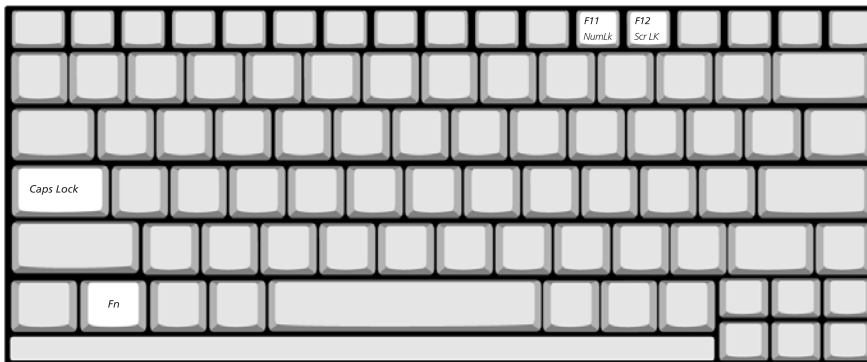

The computer features three lock keys, each with its own status indicator light.

Lock Key	Description
Caps Lock	When Caps Lock is on, all alphabetic characters are typed in uppercase. Toggle on and off by pressing the Caps Lock key on the left side of the keyboard.
Num lock	When Num Lock is on, the embedded numeric keyboard can be used. Toggle on and off by pressing the Fn+  keys simultaneously.
Scroll lock	When Scroll Lock is on, the screen toggles up or down one line at a time when the up and down cursor control keys are pressed.

**NOTE:** Scroll Lock doesn't work in all applications. Toggle on and off by pressing the Fn+F12 keys simultaneously.

---

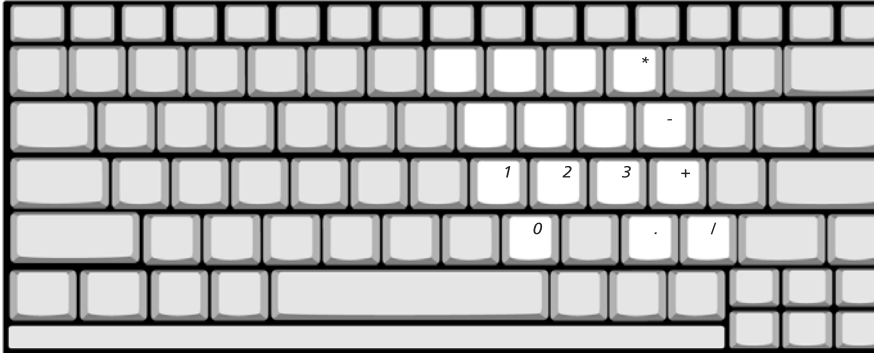

## Embedded Keypad

The embedded keypad functions like a desktop numeric keypad. It is indicated by small blue numbers and on the applicable keys.



To use the the embedded numeric keys, toggle the Num Lock on by pressing the Fn + F11 keys simultaneously.

With the embedded keypad turned on, the following actions are possible:

Desired Access	Num Lock On	Num Lock On
Number keys on embedded keypad	Type numbers using embedded keypad in the normal way.	
Cursor-control keys on embedded keypad	Hold down the  key while using the cursor keys on the embedded keypad.	Hold Fn key while using cursor-control keys.
Main keyboard keys	Hold down the Fn key while typing letters using the embedded keypad keys. Simultaneously press the  key for capital letters.	Type letters in the normal way.

---

## Hotkeys

Using the Fn key with another key creates a hot key, providing a quick and convenient method for controlling various functions.





To use a hot key, first hold down the Fn key. Next, press the second key in combination. Finally, release both keys.

### Aspire 2010





Your computer provides the following hot keys:

Hot Key	Function	Description
Fn+F1	Hot key help	This key will cause a help message to appear on the display device that describes the definition and functionality of the unit hot keys. It is preferred to have the key activate a graphical display.
Fn+F2	Access System Properties	This key will launch My Computer > System Properties
Fn+F3	Power management scheme toggle	Switches the power management scheme used by the computer (function available if supported by operating system).
Fn+F4	Sleep	In ACPI mode, the OS provides two buttons for sleep function. One is the Power On button and the other is the Sleep Button. °Fn+F4” is assigned as the Sleep button in ACPI mode. User can set the action of the Sleep Button on the Power Management property.
Fn+F5	Display toggle	The Hotkey, Display Toggle, is to change the display type at run-time. Possible display types are LCD, CRT and Both. It can not detect the CRT, even when the CRT is not connected. Press Hotkey can force to switch to CRT. This Hotkey cannot switch the display to TV at DOS.
Fn+F6	Screen blank	This key will cause the LCD back light to be turned off. This provides both a quick security feature and some power savings. The LCD back light can also be turned off via an APM timer. The LCD back light will be turned on again when any of the following events occur: <input type="checkbox"/> Any key pressed <input type="checkbox"/> Pointing device movement USB Device does not need to support.
Fn+F7	Touchpad toggle	This key will cause the internal touchpad pointing device to be disabled. This is to prevent accidental system wake-ups from standby. Pressing this key a second time will re-enable the touch pad pointing device. BIOS check Internal AuxDev ifnot exist then BIOS empty return.
Fn+F8	Speaker toggle	This key will cause the audio output to the speakers to muted or disabled. Pressing this key a second time will re-enable the audio output to the speakers.
Fn+ 	Volume up	Increases the speaker volume.
Fn+ 	Volume down	Decreases the speaker volume.
Fn+ 	Brightness up	Increases the screen brightness.
Fn+ 	Brightness down	Decreases the screen brightness.

**NOTE:** When activating hotkeys, press and hold the **Fn** key before pressing the other key in the hotkey combination.

## Aspire 2020



Your computer provides the following hot keys:







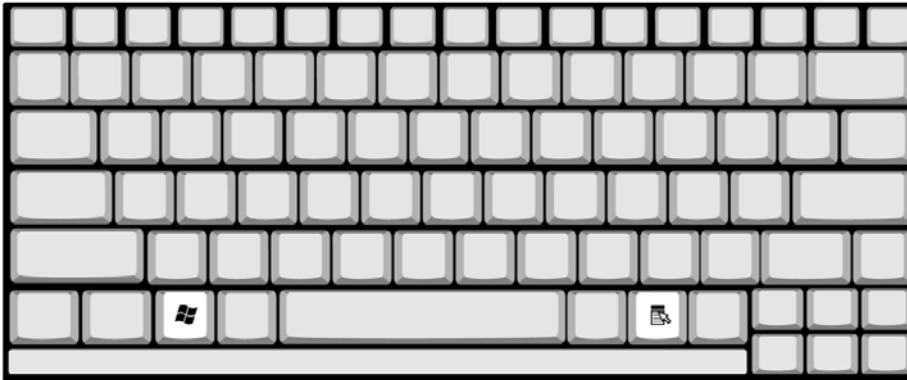

Hot Key	Function	Description
Fn+F1	Hot key help	This key will cause a help message to appear on the display device that describes the definition and functionality of the unit hot keys. It is preferred to have the key activate a graphical display.
Fn+F2	Access System Properties	This key will launch My Computer > System Properties
Fn+F3	Power management scheme toggle	Switches the power management scheme used by the computer (function available if supported by operating system).
Fn+F4	Sleep	In ACPI mode, the OS provides two buttons for sleep function. One is the Power On button and the other is the Sleep Button. °Fn+F4” is assigned as the Sleep button in ACPI mode. User can set the action of the Sleep Button on the Power Management property.
Fn+F5	Display toggle	The Hotkey, Display Toggle, is to change the display type at run-time. Possible display types are LCD, CRT and Both. It can not detect the CRT, even when the CRT is not connected. Press Hotkey can force to switch to CRT. This Hotkey cannot switch the display to TV at DOS.
Fn+F6	Screen blank	This key will cause the LCD back light to be turned off. This provides both a quick security feature and some power savings. The LCD back light can also be turned off via an APM timer. The LCD back light will be turned on again when any of the following events occur: <ul style="list-style-type: none"> <li><input type="checkbox"/> Any key pressed</li> <li><input type="checkbox"/> Pointing device movement</li> </ul> USB Device does not need to support.
Fn+F7	Touchpad toggle	This key will cause the internal touchpad pointing device to be disabled. This is to prevent accidental system wake-ups from standby. Pressing this key a second time will re-enable the touch pad pointing device. BIOS check Internal AuxDev ifnot exist then BIOS empty return.
Fn+F8	Speaker toggle	This key will cause the audio output to the speakers to muted or disabled. Pressing this key a second time will re-enable the audio output to the speakers.
Fn+↑	Volume up	Increases the speaker volume.
Fn+↓	Volume down	Decreases the speaker volume.
Fn+↶	Brightness up	Increases the screen brightness.
Fn+↷	Brightness down	Decreases the screen brightness.

**NOTE:** When activating hotkeys, press and hold the **Fn** key before pressing the other key in the hotkey combination.

## Windows Keys

The keyboard features two keys that perform Windows-specific functions.



Key	Description
Windows logo key 	Pressed alone, this key has the same effect as clicking on the Windows Start button; it launches the Start menu. It can also be used with other keys to provide a variety of functions:   + Tab (Activates the next Taskbar button)   + E (Opens the My Computer window)   + F1 (opens Help and Support)   + F (opens the Find: All Files dialog box)   + M (minimizes all windows)   + Windows logo key + M (undoes the minimize all windows action)   + R (opens the Run dialog box)
Application key 	This key has the same effect as clicking the right mouse button; it opens the application's context menu.

---

## ***Euro key***

Your computer supports the new Euro currency character. First, hold down the Alt Gr key, and then press the Euro key.

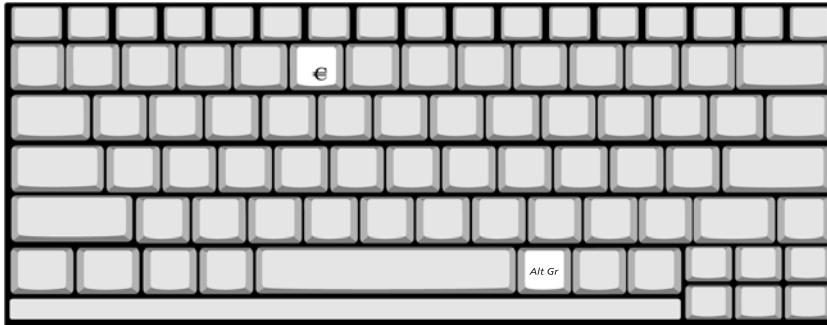

---

# Touchpad

The build-in touchpad is a PS/2 compatible pointing device that senses movement on its surface.

The cursor responds to your finger movements on the touchpad. In addition, the two click buttons provide the same functionality as a computer mouse, while the scroll key enables easy up and down scrolling in documents and web pages.

The touchpad is located in the middle of the palm rest area, providing maximum comfort and efficiency.



## Touchpad Basics

Use the touchpad as follows:



- Slide your finger over the surface of the touchpad to control the movement of the cursor. Tap the touchpad to perform selection and execution functions.
- Press the left (1) and right (3) buttons to perform selection and execution functions, just as you would use the buttons on a computer mouse.
- Use the scroll key (2) to scroll through long documents and web pages. Press the top of the key to scroll up, and the bottom to scroll down; left to scroll left, and right to scroll right.

Function	Left Button	Righ Button	4-Way Scroll Way	Tap
Execute	Click twice quickly			Tap twice (at the same speed as double-clicking the mouse button)
Select	Click once			Tap once

Function	Left Button	Righ Button	4-Way Scroll Way	Tap
Drag	Click and hold. Then slide your finger across the touchpad to drag the cursor over the selection.			Tap twice quickly. On the second tap, slide your finger across the touchpad to drag the cursor over the selection.
Access context menu			Click once	
Scroll			Click and hold the up/down/left/right button	

**NOTE:** Keep your fingers, as well as the surface of the touchpad dry and clean. The touchpad is sensitive to your finger movements: the lighter the touch, the better the response. Tapping hard will not increase the touchpad's responsiveness.

---

# Launch Keys

Located at the top of the keyboard are four buttons, in addition to the power button. These buttons are called launch keys. They are designed as key 1, key 2, key 3 and key 4, from right to left. By default, key 1 is used to launch the email application and key 2 is used to launch the Internet browser. Key 3 and key 4 start the Launch Manager application. The first four launch keys can be set by the user. To set the launch keys, run the Acer Launch Manager.

**Aspire 2010**



**Aspire 2020**



#	Description
Email	Launches your email application.
Web browser	Launches your Internet browser
P1	User-programmable
P2	User-programmable

# Hardware Specifications and Configurations

## Processor

Item	Specification
CPU type	Intel® Centrino™ mobile Pentium M processor at 1.4~ 1.8 GHz
CPU package	uFCPGA package
CPU core voltage	Support automatic selection of power supply voltage
CPU I/O voltage	1.05V

## BIOS

Item	Specification
BIOS vendor	Insyde
BIOS Version	Insyde MobilePRO BIOS 1.0
BIOS ROM type	Flash ROM
BIOS ROM size	512KB
BIOS package	32 lead of TSSOP
Supported protocols	ACPI 1.0b, PC Card 95, SM BIOS 2.3, EPP/IEEE 1284, ECP/IEEE 1284 1.7 & 1.9, PCI 2.2, PnP 1.0a, DMI 2.0, USB, VGA BIOS, CD-ROM bootable
BIOS password control	Set by setup manual

## Second Level Cache

Item	Specification
Cache controller	Built-in CPU
Cache size	1MB or 2MB
1st level cache control	Always enabled
2nd level cache control	Always enabled
Cache scheme control	Fixed in write-through

## System Memory

Item	Specification
Memory controller	Intel 855GME
Memory size	128MB/256MB/512MB/1GB
DIMM socket number	2 sockets
Supports memory size per socket	1024MB
Supports maximum memory size	2GB (by two 1024MB SO-DIMM module)
Supports DIMM type	DDR Synchronous DRAM
Supports DIMM Speed	333MHz
Supports DIMM voltage	2.5V
Supports DIMM package	200-pin SO-DIMM
Memory module combinations	You can install memory modules in any combinations as long as they match the above specifications.



### Memory Combinations

Slot 1	Slot 2	Total Memory
256/512MB	0 MB	256MB/512MB
256/512MB	256MB	512MB/768MB
256/512MB	512MB	768MB/1024MB

**NOTE:** Above table lists some system memory configurations. You may combine DIMMs with various capacities to form other combinations.

### LAN Interface

Item	Specification
Supports LAN protocol	10/100 Mbps ( <b>Aspire 2010</b> ) 10/100/100 Mbps ( <b>Aspire 2020</b> )
LAN connector type	RJ45
LAN connector location	Rear side

### Modem / Bluetooth Interface

Item	Specification
Data modem data baud rate (bps)	56K
Supports modem/bluetooth protocol	V.92 for MDC / Bluetooth 1.1 standard for BT modem
Modem connector type	RJ11
Modem connector location	Rear side

### Hard Disk Drive Interface

Item	Specification					
VENDOR MODEL NAME	HITACHI IC25N0X0AT MR04-0	HITACHI HTS428060 F9AT00	HITACHI HTS5480X0 M9AT00	TOSHIBA MKX025GAS	TOSHIBA MK6026GAX	SEAGATE ST94019A
CAPACITY (GB)	30/40/60/80	60	60/80	40/60	60	40
DISK HEAD	2/2/3/4	3	3/4	2/3	3	2
DISK	1/1/2/2	2	2/2	1/2	2	1
SPINDLE RPM	4200	4200	5400	4200	5400	4200
CACHE BUFFER (MB)	2/2/8/6	8	8	8/8	16	2
INTERFACE MODE	ULTRA DMA 100	ULTRA DMA 100	ULTRA DMA 100	ULTRA DMA 100	ULTRA DMA 100	ULTRA DMA 100
DC REQUIRE	5V +/- 5%	5V +/- 5%	5V +/- 5%	5V +/- 5%	5V +/- 5%	5V +/- 5%

## Optical Drive Interface

Item	Specification	
Vendor & model name	Panasonic	
Model	<b>Aspire 2010</b>	<b>Aspire 2020</b>
Optical Media Drive	DVD/CD-RW combo drive DVD Dual Drive	DVD-Super Multi Drive DVD/CD-RW Combo Drive
Disc Performance compatibility	Optical Drive Options: <ul style="list-style-type: none"> <li><input type="checkbox"/> DVD/CD-RW combo drive               <ul style="list-style-type: none"> <li><input type="checkbox"/> Read: 8X DVD-ROM, 24X CD-ROM</li> <li><input type="checkbox"/> Write: 24X CD-R, 10X CD-RW</li> </ul> </li> <li><input type="checkbox"/> DVD-Dual Drive               <ul style="list-style-type: none"> <li><input type="checkbox"/> Read: 4X DVD+R, 4X DVD+RW, 4X DVD-R, 4X DVD-RW, 8X DVD-ROM, 24X CD-ROM</li> <li><input type="checkbox"/> Write: 2.4X DVD+R, 2.4X DVD-RW, 2X DVD-R, 2X DVD-RW, 16X CD-R, 10X CD-RW</li> </ul> </li> </ul>	Slot-loading optical drive options <ul style="list-style-type: none"> <li><input type="checkbox"/> Slot-loading DVD-Super Multi Drive               <ul style="list-style-type: none"> <li><input type="checkbox"/> Read: 4X DVD-R, 4X DVD-RW, 4X DVD+R, 4X DVD+RW, 8X DVD-ROM, 24X CD-ROM, 2X DVD-RAM</li> <li><input type="checkbox"/> Write: 2.4X DVD+R, 2.4X DVD+RW, 4X DVD-R, 2X DVD-RW, 16X CD-R, 8X CD-RW, 2X DVD-RAM</li> </ul> </li> <li><input type="checkbox"/> Slot-loading DVD/CD-RW combo drive               <ul style="list-style-type: none"> <li><input type="checkbox"/> Read: 8X DVD-ROM, 24X CD-ROM</li> <li><input type="checkbox"/> Write: 24X CD-R, 10X CD-RW</li> </ul> </li> </ul>
Data Buffer Capacity	2 MBytes	
Interface	IDE ( ANSI ATA/ATAPI-5)	
Read Function		
Applicable Discs	CD-ROM Mode 1 CD-ROM XA CD-Audio Mixed Mode CD-ROM (Audio and Data Combined) Photo-CD (Single and Multi-session) CD-I, Video CD CD Plus/ CD Extra, CD-Text CD-R disc CD-RW disc	DVD-ROM single Layer 4.7GB, dual Layer 8.5GB DVD-R: 3.95/4.7GB DVD-RW: 4.7GB DVD-RAM: 2.6/4.7GB
Write Function		
Applied Format	CD-ROM Mode-1 CD-ROM XA CD-Audio Mixed Mode (Audio and Data Combined) CD-I, Video CD CD-Plus / CD-Extra , CD-Text	
Writing Method	Disc at once (DAO) Session at once (SAO) Track at once (TAO) Variable packet writing Fixed packet writing Multi-session	

### ***Optical Drive Interface***

Item	Specification
Loading mechanism	Load: The disc can be loaded semi-automatically ( To load the disc in the drive, it is needed to push the disc manually) Unload: The disc can be unloaded automatically by motor powered mechanism. The disc unloading can be operated by the Eject button or Eject Command through the IDE interface.
Power Requirement	
Input Voltage	+5V $\pm$ 5 % Ripple Less than 100mVp-p

### ***Audio Interface***

Item	Specification
Audio Controller	Realtek ALC250, AC97 Codec
Audio onboard or optional	Built-in, support CD playback when system off
Mono or Stereo	Stereo
Resolution	20 bit stereo Digital to analog converter 18 bit stereo Analog to Digital converter
Compatibility	Microsoft PC99, AC97 2.2 & WHQL
Mixed sound source	CD
Sampling rate	48 KHz
Internal microphone	Yes
Internal speaker / Quantity	Yes / 2

### ***Video Interface***

Item	Specification
Video vendor	ATI
Video name	M11P
Chip voltage	Core/1.5V
Supports ZV (Zoomed Video) port	No

### ***Video Resolution Mode (for both LCD and CRT)***

Resolution	16 bits (High color)	32 bits (True color)
1024*768	Yes	Yes
1400*1050 (SXGA)	Yes	Yes
1600*1200 (UXGA)	Yes	Yes
1280*1024 (Monitor)	Yes	Yes

### ***Parallel Port***

Item	Specification
Parallel port controller	Intel ICH4-M
Number of parallel port	One
Location	Rear side
Connector type	25-pin D-type connector, in female type

### **Parallel Port**

Item	Specification
Parallel port function control	Enable/Disable/Auto (BIOS or operating system chooses configuration) by BIOS setup <b>Note:</b> Depending on your operating system, disabling an unused device may help free system resources for other devices.
Supports ECP/EPP/Bi-directional (PS/2 compatible)	Yes (set by BIOS setup) <b>Note:</b> When Mode is selected as EPP mode, "3BCh" will not be available.
Optional ECP DMA channel (in BIOS setup)	DMA channel 1
Optional parallel port I/O address (in BIOS setup)	378h, 278h
Optional parallel port IRQ (in BIOS setup)	IRQ7, IRQ5

### **USB Port**

Item	Specification
USB compliancy level	2.0
OHCI	USB 2.0
Number of USB port	3
Location	Rear side
Serial port function control	Enable/Disable by BIOS setup

### **PCMCIA Port**

Item	Specification
PCMCIA controller	ENE CB1410 CardBus
Supports card type	Type II
Number of slots	One type-II
Access location	Left panel
Supports ZV (Zoomed Video) port	No ZV support
Supports 32 bit CardBus	Yes

### **System Board Major Chips**

Item	Controller
System core logic	Intel 855GME and ICH4-M
Super I/O controller	SMSC LPC47N217, LPC bus
Audio controller	Realtek ALC202A Codec
Video controller	ATI M11-P
Hard disk drive controller	ICH4-M
Keyboard controller	ENE KB910
RTC	ICH4-M

### Keyboard

Item	Specification
Keyboard controller	ENE KB910
Keyboard vendor & model name	Standard keyboard w/o launch button embeded
Total number of keypads	84/85/88 keys with 101/102 key emulation inverted "T" cursor layout ; 3mm(minimum) key travel
Windows logo key	Yes
Internal & external keyboard work simultaneously	Yes

### Battery

Item	Specification
Vendor & model name	Samsung
Battery Type	Li-ion
Pack capacity	64 Whr
Cell voltage	3.7V/cell
Number of battery cell	8
Battery Charge	5-hour battery life for 8-cell battery 2-hour quick-charge time; 3.5-hour charge-in-use
Adapter	65W AC Adapter

### LCD Inverter Specification

No.	Supplier	Model	Type
1	LG	LP154W01-A3	15.4" WXGA
2	Samsung	LTN154X1-L02	15.4" WXGA
3	AU	B154EW01	15.4" WXGA
4	QDI	5TL02	15.4" WXGA

### LCD

Item	Specification			
Vendor & model name	Samsung LTN154X1-L02	LG LP154W01-A3	QDI 5TL02	AU B154EW01
Mechanical Specifications				
LCD display area (diagonal, inch)	15.4"	15.4"	15.4"	15.4"
Display technology	TFT	TFT	TFT	TFT
Resolution	WXGA (1280* 800)	WXGA (1280* 800)	WSXGA (1280* 800)	WSXGA (1280* 800)
Supports colors	262K	262K	262K	262K
Optical Specification				
Brightness control	keyboard hotkey	keyboard hotkey	keyboard hotkey	keyboard hotkey
Contrast control	No	No	No	No

## LCD

Item	Specification			
Suspend/Standby control	Yes	Yes	Yes	Yes
Electrical Specification				
Supply voltage for LCD display (V)	3.3	3.3	3.3	3.3
Supply voltage for LCD backlight (Vrms)	690	690	690	690

## AC Adapter

Item	Specification
Vendor & model name	Delta ADP-65DB Liteon PA-1650-02CR
Input Requirements	
Maximum input current (A, @100Vac, full load)	1.5A max@3.5A/100Vac and 240 Vac
Nominal frequency (Hz)	47 - 63
Frequency variation range (Hz)	47 - 63
Nominal voltages (Vrms)	90 - 264
Inrush current	The maximum inrush current will be less than 50A and 100A when the adapter is connected to 100Vac(60Hz) and 240Vac(50Hz) respectively.
Efficiency	High efficiency 85% minimum, at 100~240Vac AC input, full load, warm-up condition.
Output Ratings (CV mode)	
DC output voltage	Offers constant voltage 19.0V output source with 65W max output power capacity.
Noise + Ripple	300mvp-pmax (20MHz bandwidth) for resistor load
Output current	0 A (min.) 3.5A (max.)
Output Ratings (CC mode)	
DC output voltage	18.0 ~ 20.0
Constant output	3.5A
Dynamic Output Characteristics	
Start-up time	3 sec. (@115 Vac and 230Vac full load)
Hold up time	5ms min. (@115 Vac input, full load)
Over Voltage Protection (OVP)	25V
Short circuit protection	Output can be shorted without damage, and auto recovery
Electrostatic discharge (ESD)	15kV (at air discharge) 8kV (at contact discharge)
Dielectric Withstand Voltage	
Primary to secondary	4242 Vdc for 1 second
Leakage current	60uA at 240Vac/60Hz
Regulatory Requirements	1. FCC class B requirements (USA) 2. VDE class B requirements (German) 3. VCCI classII requirements (Japan)

## Power Management

ACPI Mode	Power Management
Mech. Off (G3)	All devices in the system are turned off completely.
Soft Off (G2/S5)	OS initiated shutdown. All devices in the system are turned off completely.
Working (G0/S0)	Individual devices such as the CPU and hard disk may be power managed in this state.
Sleeping State (S3)	CPU Power Down VGA Power Down PCMCIA Suspend Audio Power Down Hard Disk Power Down Super I/O Power Down
Sleeping State (S4)	Also called Hibernate state. System saves all system states and data onto the disk prior to power off the whole system.

## Environmental Requirements

Item	Specification
Temperature	
Operating	+5 ~ +35°C
Non-operating	-20 ~ +65°C
Non-operating	-20 ~ +65°C (storage package)
Humidity	
Operating	10% to 90% without condensation
Non-operating	10% to 90% RH, non-condensing (unpacked)
Non-operating	10% to 90% RH, non-condensing (storage package)
Vibration	
Operating (unpacked)	5 ~ 500Hz: 0.9G
Non-operating (unpacked)	5 ~ 500Hz: 1.3G

## Mechanical Specification

Item	Specification
Dimensions	360mm (W) x 273mm (D) x 28-33.49mm (H) (14.2x10.7x1.1-1.32 inches) <b>NOTE:</b> The size and weight of individual units may vary depending on configuration.
Weight	3 kg (6.6lbs) <b>NOTE:</b> The size and weight of individual units may vary depending on configuration.
I/O Ports	Three USB 2.0 Ports, one IEEE 1394 port, one Ethernet (RJ-45) port , one Modem (RJ-11) port, one S-video/TV-out(NTSC/PAL) port, one Parallel port, one External display (VGA) port, one Microphone/line-in jace, one Headphone/speaker/line-out jack, one Infrared (FIR) port, one PC card slot (type II), one DC-in jack for AC adapter
Drive Bays	One

---

***Mechanical Specification***

Item	Specification
Material	Recycle plastic PC+ABS 94V0
Indicators	Power, Media activity, Battery charge, Wireless/Bluetooth communication, Caps lock, Pad lock, Num lock and Scroll lock indicators
Switch	Power switch Lid switch Touch pad Left/Right



## System Utilities

### BIOS Setup Utility

The BIOS Setup Utility is a hardware configuration program built into your computer's BIOS (Basic Input/Output System).

Your computer is already properly configured and optimized, and you do not need to run this utility. However, if you encounter configuration problems, you may need to run Setup. Please also refer to Chapter 4 Troubleshooting when problem arises.

To activate the BIOS Utility, press **F2** during POST (when "Press <F2> to enter Setup" message is prompted on the bottom of screen).

The setup screen displays BIOS as follows: Navigating the BIOS Utility

Function	Item
Screen	Display system information
Main	Set Date and Time
	Enable/Disable Quiet Boot Logo
	Enable/Disable LCD Auto DIM
	Enable/Disable Network Boot
	Enable/Disable F12 Boot Menu
Advanced	Allow users to set FIR ports
	Allow users to set LPT ports
	Allow users to enable/disable legacy USB
Security	Set User passwords
	Set Supervisor passwords
	Enable/Disable HDD Drive Lock
	Enable/Disable Password on Boot
Boot	Allow users to change boot up devices priorities
Exit	Exit and save settings

There are five menu options: Main, Advanced, Security, Boot and Exit.

Follow these instructions:

- To choose a menu, use the cursor left/right keys (**←** **→**).
- To choose a parameter, use the cursor up/down keys (**↑** **↓**).
- To change the value of a parameter, press **F5** or **F6**.
- Press **ESC** while you are in any of the menu options to go to the Exit menu.
- In any menu, you can load default settings by pressing **F9**. You can also press **F10** to save any changes made and exit the BIOS Setup Utility.

**NOTE:** You can change the value of a parameter if it is enclosed in square brackets. Navigation keys for a particular menu are shown on the bottom of the screen. Help for parameters are found in the Item Specific Help part of the screen. Read this carefully when making changes to parameter values.

Insyde Software SCU May 20, 2003  
 5:40:09 AM

Main
Advanced
Security
Boot
Exit

----Devices-----

Product Name = Aspire 2010  
 Manufacture Name = Acer  
 System BIOS Version = V1.00  
 VGA BIOS Version =

**HDD Model Name** = HITACHI\_DK23EA-40  
 HDD Serial Number = 8D4648  
**ATAPI Model Name**= UJDA740 DVD/CDROM

Serial #: ( 32 bytes)  
 Asset Tag#: (32 bytes)  
 UUID = (16 bytes)

----System-----

CPU = Intel® Pentium ® M  
 CPU Speed = 1600 MHz

----Memory-----

Base Memory = 640 KB  
 Extended Memory = 255MB  
 VGA Memory = 64 MB

Setup system date, time. Enable boot logo and get system information.

Parameter	Description
Product Name	This field will show product name.
Manufacture Name	This field will show manufacturer name.
System BIOS Version	This field reports the BIOS version of system.
VGA BIOS Version	This field reports the VGA version of the system.
Hard Disk Mode Name	This item will show the size of HDD installed on Primary IDE master. The hard disk size is automatically detected by the system. If there is no hard disk present or unknown type, "None" should be shown on this field.
HDD Serial Number	This item allows the serial number of the Hard Disk. If there is no hard disk present or unknown type, "None" should be shown on this field.
ATAPI	This item will show the model name of DVD/CD-ROM drive installed on system. The DVD/CD-ROM model name is automatically detected by the system. If there is no DVD/CD-ROM model present or unknown type, "None" should be shown on this field.
Serial Number	This item will show the Serial number of system.
Asset Tag	This item will show the Asset Tag number of the system.
UUID	This number only valid when there is an internal LAN device presents, otherwise, zero will be display in this field.
System	First field reports the model name of processor. Second field reports CPU Speed.

---

## Memory

Parameter	Description
Base	This field reports the base memory size of system.
Extended	This field reports the extended memory size of the system.
VGA BIOS Version	This field reports the VGA BIOS version of system.

# Main

This menu provides you the information of the system.

Insyde Software SCU		May 20, 2003 5:40:09																					
Main	Advanced	Security	Boot	Exit																			
<b>Date and Time</b> v Quiet Boot v <u>LCD Auto DIM</u> v <u>Network Boot</u> <u>F12 Boot Menu</u>		<table border="1"> <thead> <tr> <th colspan="4">-----Date and Time-----</th> </tr> </thead> <tbody> <tr> <td>Day</td> <td>20</td> <td>Hour</td> <td>8</td> </tr> <tr> <td>Month</td> <td>5</td> <td>Minute</td> <td>35</td> </tr> <tr> <td>Year</td> <td>2003</td> <td>Second</td> <td>9</td> </tr> <tr> <td colspan="2">OK</td> <td colspan="2">Cancel</td> </tr> </tbody> </table>		-----Date and Time-----				Day	20	Hour	8	Month	5	Minute	35	Year	2003	Second	9	OK		Cancel	
-----Date and Time-----																							
Day	20	Hour	8																				
Month	5	Minute	35																				
Year	2003	Second	9																				
OK		Cancel																					
<Tab> <Right> <Left> for block select. <Up> <Down> for item select. <Enter> for accept. <Cancel> <Esc> for reject. <Alt> activates accelerators. <Space> for Enable or Disable.																							

Parameter	Description
Date and Time	The hours are displayed with 24 hours format. The values set in these two fields take effect immediately.
Quiet Boot	Customer Logo display will be shown during POST when it is selected.
LCD Auto DIM	When this is selected, brightness of the LCD will be reduced for power saving when adaptor has been removed from the system. When this is not selected, brightness of the LCD will remain the same after adaptor has been removed from the system.
Network Boot	When this is selected, Boot from LAN feature is enabled. When this is not selected, Boot from LAN feature is then disabled.
F12 Boot Menu	When this is selected, users can modify device boot priority by pressing F12 key during POST. When this is not selected, device boot priority will not be adjustable during POST.

## Quiet Boot

Customer Logo display will be shown during POST when it is selected.

Insyde Software SCU		May 20, 2003 5:40:09		
Main	Advanced	Security	Boot	Exit
Date and Time				
▼ Quiet Boot				
▼ <u>LCD Auto DIM</u>				
▼ <u>Network Boot</u>				
<u>F12 Boot Menu</u>				
Display big boot logo on screen when system is booting. <Space> for Enable or Disable.				

## F12 Boot Menu

When this is selected, users can modify device boot priority by pressing F12 key during POST. When this is not selected, device boot priority will not be adjustable during POST. Default is disabled.

Insyde Software SCU		May 20, 2003 5:40:09		
Main	Advanced	Security	Boot	Exit
Date and Time				
▼ Quiet Boot				
<u>LCD Auto DIM</u>				
▼ <u>Network Boot</u>				
Enable or disable lan boot function, <Space> for Enable or Disable.				

## LCD Auto DIM

When this is selected, brightness of the LCD will be reduced for power saving when adaptor has been removed from the system.

When this is not selected, brightness of the LCD will remain the same after adaptor has been removed from the system.

Insyde Software SCU		May 20, 2003 5:40:09		
Main	Advanced	Security	Boot	Exit
Date and Time				
√ Quiet Boot				
√ Network Boot				
√ F12 Boot Menu				
Enable or disable the F12 key for Boot Menu during Post <Space> for Enable or Disable.				

## Network Boot

When this is selected, Boot from LAN feature is enabled. When this is not selected, Boot from LAN feature is then disabled.

Insyde Software SCU		May 20, 2003 5:40:09		
Main	Advanced	Security	Boot	Exit
Date and Time				
√ Quiet Boot				
<u>LCD Auto DIM</u>				
√ F12 Boot Menu				
Enable or disable auto dim function, <Space> for Enable or Disable.				

## Advanced

The Advanced screen contains parameters involving your hardware devices. It also provides advanced settings of the system.

### FIR Ports

Configure the system's infrared port using options: **Disabled** and Enabled.

-----FIR Ports-----

----FIR I/O settings---

( ) Disabled

( ) COM1,3F8,IRQ4

( ) COM2,2F8,IRQ3

( ) COM3,3E8,IRQ4

(•) COM4,2E8,IRQ3

-Mode Setting for IRDA-

( ) Normal (16550)

( ) IrDA (HPSIR)

( ) ASK IR

(•) FAST IR

--DMA Setting For Fast IR--

( ) DMA1

( ) DMA2

( ) DMA3

OK Cancel

<Tab> <Right> <Left> for block select. <Up> <Down> for item select.  
 <Enter> for accept. <Cancel> <Esc> for reject. <Alt> activates accelerators.  
 <Space> for Enable or Disable.

The table below describes the parameters in the screen. Settings in **boldface** are the default and suggested parameter settings.

	Description	Option
FIR I/O Settings	Sets the base I/O address and IRQ for Infrared port.	COM1, 3F8, IRQ4/ COM2, 2F8, IRQ3/ COM3, 3E8, IRQ4/ <b>COM4, 2E8, IRQ3</b>
DMA Setting for Fast IR	Sets a DMA channel for the printer to operate in ECP mode. This parameter is enabled only if Mode is set to ECP.	DMA1, DMA2, <b>DMA3</b> ,
Mode Setting		Normak (16550), IrDA (HPSIR), ASK IR, <b>FAST IR</b>

## LPT Port

Configure the system's parallel port using options: **Disabled** and Enabled.

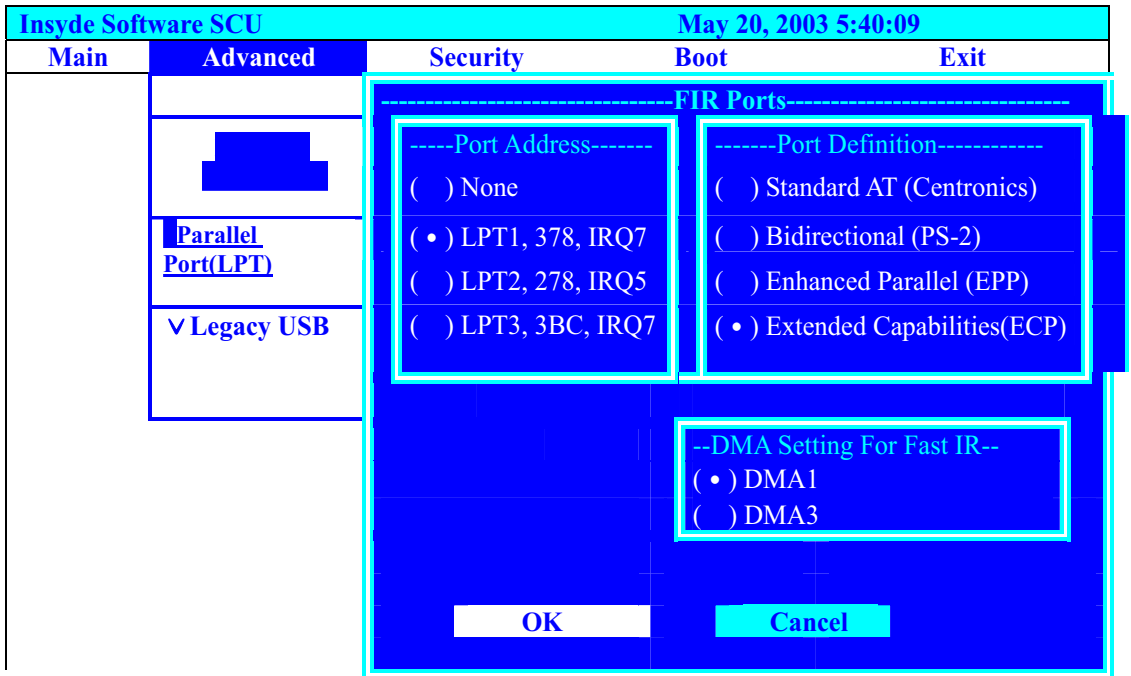

The table below describes the parameters in the screen. Settings in **boldface** are the default and suggested parameter settings.

	Description	Option
Port Address	Sets the base I/O address for the parallel port. When Mode is selected as EPP mode, "3BC" will not be available.	None/ <b>LPT1, 378, IRQ7</b> / LPT2, 278, IRQ5/ LPT3, 3BC, IRQ7
Port Definition	Sets the mode for the parallel port. Standard AT: Normal mode (AT compatible) Bi-directional: Bi-directional mod (PS/2 compatible) Enhanced Parallel (EPP): EPP mode Extended Compabilities (ECP): ECP mode (requires DMA channel)	Standard AT (Centronics), Bidirectional (PS-2), Enhanced Parallel (EPP), <b>Extended Capabilities(ECP)</b>
DMA Setting for Fast IR	If ECP mode has been selected, then DMA default is DMA1.	<b>DMA1</b> , DAM3



---

## Legacy USB Support

Insyde Software SCU		May 20, 2003 5:40:09		
Main	Advanced	Security	Boot	Exit
	<div style="border: 1px solid black; padding: 5px;"><div style="border: 1px solid black; padding: 2px;">Parallel Port(LPT)</div><div style="border: 1px solid black; padding: 2px; background-color: #0000FF; color: white; text-align: center;">v Legacy USB</div></div>			
Legacy USB keyboard Floppy Disk USB Mouse Support <Space> for Enable or Disable				

Option	Description
Disabled	Disable support for Legacy Universal Serial Bus
Enabled	Enable support for Legacy Universal Serial Bus.

# Security

The Security screen contains parameters that help safeguard and protect your computer from unauthorized use.

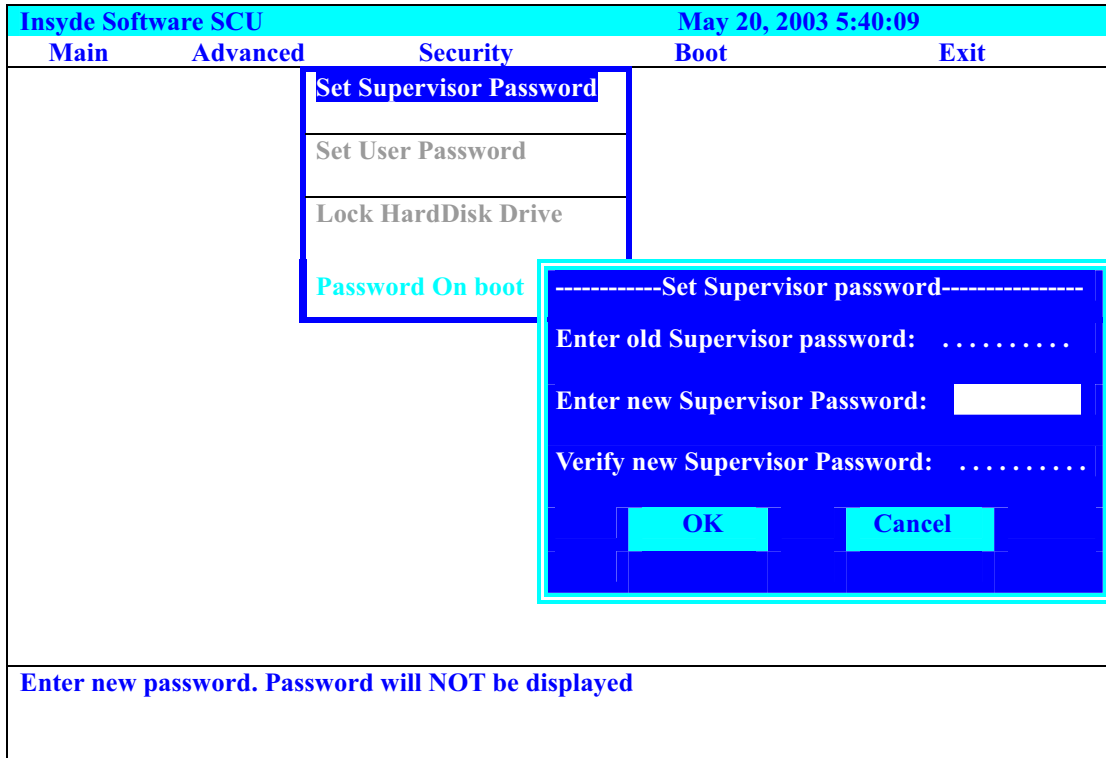

The table below describes the parameters in this screen. Settings in **boldface** are the default and suggested parameter settings.

## Set Supervisor/User Password

If password on boot is required, the password must be set otherwise it cannot be enabled.

The formats of the password are as follows:

Length      No more than 8 characters

Characters   0-9,A-Z (not case sensitive)

Parameter	Description	Option
Set User Password	Press Enter to set the user password. When set, this password protects the BIOS Setup Utility from unauthorized access.	Length -- No more than 8 characters Characters -- 0-9, A-Z (not case sensitive)
Set Supervisor Password	Press Enter to set the administrator password. When set, this password protects the BIOS Setup Utility from unauthorized access.	

Parameter	Description	Option
Lock Hard Disk Drive	<p>This feature is available to user when Supervisor password is set. Password can be written on HDD only when Supervisor password or user password is set and password onHDD is set to enabled. Supervisor Password is written to HDD when only Supervisor password is being set. User password is written to HDD when both passwords are set. When both Supervisor and user passwords are present, both passwords can unlock the HDD.</p>	Disabled/Enabled
Password on Boot	<p>Defines whether a password is required or not while the events defined in this group happened. The following sub-options are all requires the Supervisor password for changes and should be grayed out if the user password was used to enter setup.</p> <p>Allows the user to specify whether or not a password is required to boot.</p>	Check Uncheck

# Boot

This menu allows the user to decide the order of boot devices to load the operating system. Bootable devices includes the distette drive in module bay, the onboard hard disk drive and the CD-ROM in module bay and onboard LAN device.

**Insyde Software SCU** May 20, 2003 5:40:09

Main    **Advanced**    Security    **Boot**    Exit

**Boot Device**

-----**Boot Device**-----

---1st Boot Device---	---2 <sup>nd</sup> Boot Device---	--3 <sup>rd</sup> Boot Device----
<input type="checkbox"/> Hard Drive	<input checked="" type="checkbox"/> Hard Drive	<input type="checkbox"/> Hard Drive
<input type="checkbox"/> CD-ROM/DVD Drive	<input type="checkbox"/> CD-ROM/DVD Drive	<input checked="" type="checkbox"/> CD-ROM/DVD Drive
<input checked="" type="checkbox"/> Floppy Drive	<input type="checkbox"/> Floppy Drive	<input type="checkbox"/> Floppy Drive
<input type="checkbox"/> Network Boot	<input type="checkbox"/> Network Boot	<input type="checkbox"/> Network Boot

USB Mass storage

**OK**    **Cancel**

**<Tab> <Right> <Left> for block select. <Up> <Down> for item select.  
<Enter> for accept. <Cancel> <Esc> for reject. <Alt> activates accelerators.  
<Space> for Enable or Disable.**

# Exit

The Exit screen contains parameters that help safeguard and protect your computer from unauthorized use.

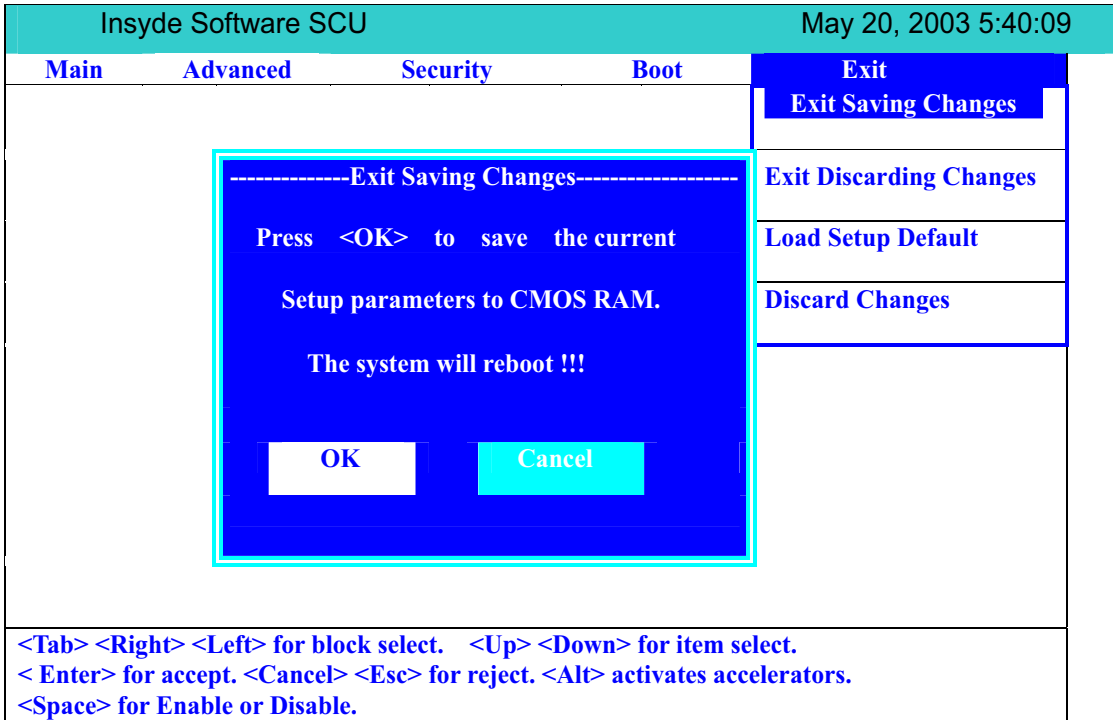

The table below describes the parameters in this screen.

Parameter	Description
Exit Saving Changes	Allows the user to save changes to CMOS and reboot the system.
Exit Discarding Changes	Allows the user Discards changes made and exits System Setup.
Load Setup Default	Loads default settings for all parameters (same as  ).
Discard Changes	Allows the user to discard previous changes in CMOS Setup.

## Exit Discarding Changes

Exit without saving current settings.

Insyde Software SCU				May 20, 2003 5:40:09	
Main	Advanced	Security	Boot	Exit	
				Exit Saving Changes	
				Exit Discarding Changes	
				Load Setup Default	
				Discard Changed	

-----Exit Discarding Changes-----

Press <OK> to Exit the SCU.

The current settings will not be saved!!!

<Tab> <Right> <Left> for block select. <Up> <Down> for item select.  
<Enter> for accept. <Cancel> <Esc> for reject. <Alt> activates accelerators.  
<Space> for Enable or Disable.

## Load Setup Default

Load manufacture default settings.

Insyde Software SCU				May 20, 2003 5:40:09	
Main	Advanced	Security	Boot	Exit	
				Exit Saving Changes	
				Exit Discarding Changes	
				Load Setup Default	
				Discard Changed	

-----Load Setup Default-----

Do you wish to change the current setup  
to the system default values?

<Tab> <Right> <Left> for block select. <Up> <Down> for item select.  
<Enter> for accept. <Cancel> <Esc> for reject. <Alt> activates accelerators.  
<Space> for Enable or Disable.

## Discard Changes

Restore current settings to original settings.

Insyde Software SCU				May 20, 2003 5:40:09	
Main	Advanced	Security	Boot	Exit	
				Exit <b>S</b> aving Changes	
				Exit <b>D</b> iscarding Changes	
				Load Setup Default	
				Discard Changed	
<p>-----Discard Changes-----</p> <p>Do you wish to restore the current setup to the original custom values?</p> <p>OK Cancel</p>					
<p>&lt;Tab&gt; &lt;Right&gt; &lt;Left&gt; for block select. &lt;Up&gt; &lt;Down&gt; for item select. &lt;Enter&gt; for accept. &lt;Cancel&gt; &lt;Esc&gt; for reject. &lt;Alt&gt; activates accelerators. &lt;Space&gt; for Enable or Disable.</p>					

---

## ***BIOS Flash Utility***

The BIOS flash memory update is required for the following conditions:

- New versions of system programs
- New features or options
- Restore a BIOS when it becomes corrupted.

Use the Flash utility to update the system BIOS flash ROM.

**NOTE:** If you do not have a crisis recovery diskette at hand, then you should create a **Crisis Recovery Diskette** before you use the Flash utility.

**NOTE:** Do not install memory-related drivers (XMS, EMS, DPMS) when you use the Flash utilities.

**NOTE:** Please use the AC adaptor power supply when you run the Flash utility. If the battery pack does not contain enough power to finish BIOS flash, you may not boot the system because the BIOS is not completely loaded.

Follow the steps below to run the Flash.

1. Prepare a bootable diskette.
2. Copy the Flash utilities to the bootable diskette.
3. Then boot the system from the bootable diskette. The Flash utility has auto-execution function.

## ***System Diagnostic Diskette***

This diagnostic diskette is for the Acer Aspire 2010/2020 series notebook machine. However, system diagnostic utility is not ready as service CD released. Acer HQ CSD will upload the utility to CSD website as soon as it is ready.



## *Machine Disassembly and Replacement*

---

This chapter contains step-by-step procedures on how to disassemble the notebook computer for maintenance and troubleshooting.

To disassemble the computer, you need the following tools:

- Wrist grounding strap and conductive mat for preventing electrostatic discharge
- small Philips screwdriver
- flat head screwdriver
- Philips screwdriver
- nut screwdriver
- tweezers

**NOTE:** The screws for the different components vary in size. During the disassembly process, group the screws with the corresponding components to avoid mismatch when putting back the components.

When you remove the stripe cover, please be careful not to scrape the cover.

**NOTE:** This chapter will base on Aspire 2000 to modify. If you need to read the mpeg files please refer to Aspire 2000 Service CD, and the P/N is **VD.A20V5.001**

---

## ***General Information***

### ***Before You Begin***

Before proceeding with the disassembly procedure, make sure that you do the following:

1. Turn off the power to the system and all peripherals.
2. Unplug the AC adapter and all power and signal cables from the system.
3. Remove the battery pack.

# Disassembly Procedure Flowchart

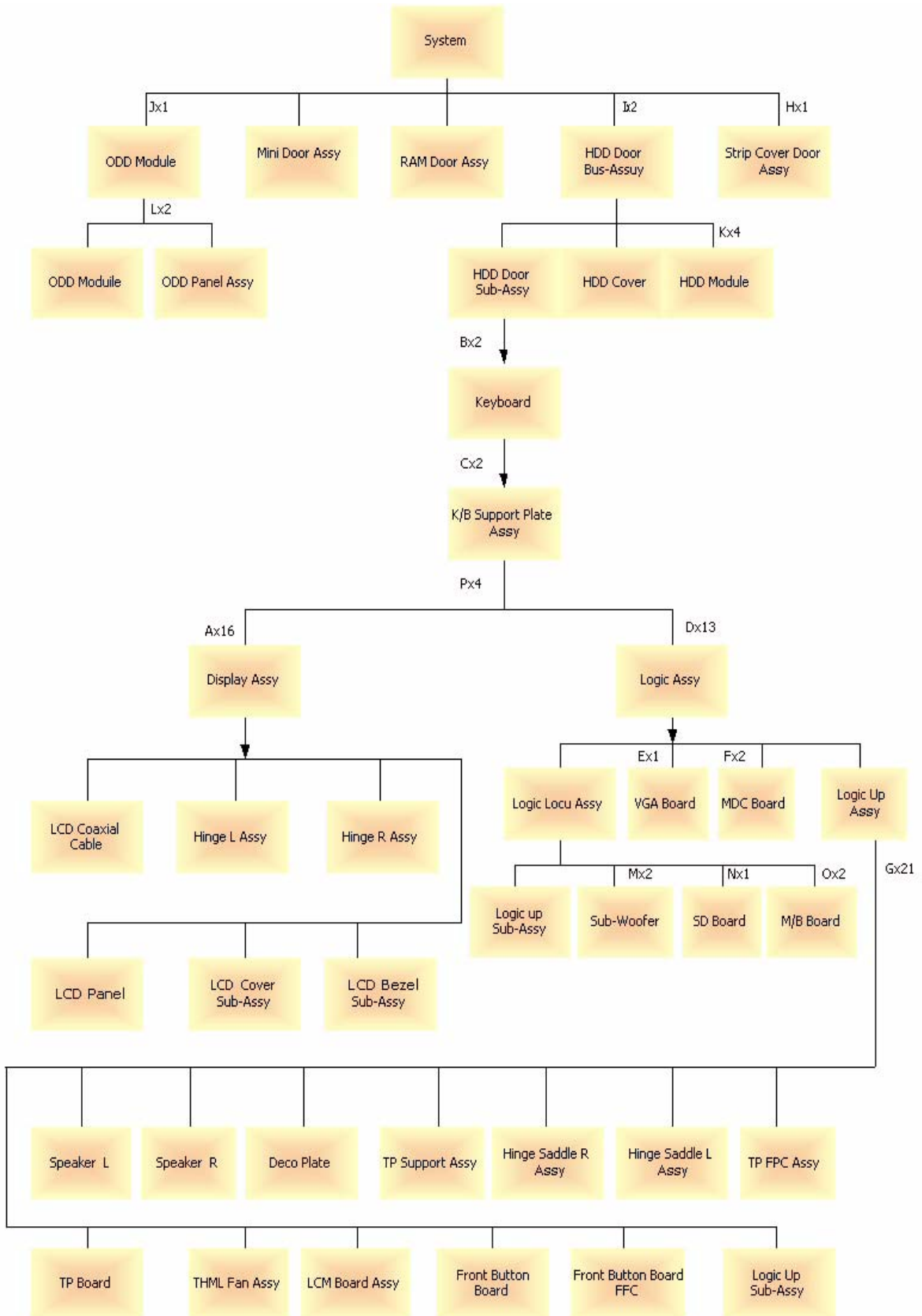

---

Item	Description
A	M2.5x5 M2.0x4
B	M2.5x3
C	M2.5x4
D	M2.5x10 M2.5x4
E	M2.5x14
F	M2.0x4
G	M2.5x4
H	M2.5x14
I	M2.5x10
J	M2.5x5
K	M3.0x3
L	M2.0x3
M	2.5x4
N	M2.5x4
O	M2.5x5
P	M2.5x4

---

## ***Aspire 2010/2020 Disassembly Procedure***

This section will guide you how to disassemble the system when you need to perform system service. Please also refer to the disassembly video, if available.

**CAUTION:** Before you proceed, make sure you have turned off the system and all peripherals connected.

### ***Disassemble the Battery and HDD***

1. Release the battery lock and slide the battery latch.
2. Then remove the battery pack.
3. Remove the two screws to release the hard drive door. Then take it away.

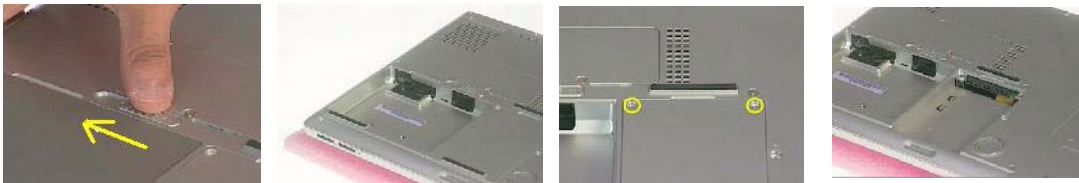

### ***Disassemble the Wireless***

1. Remove the one screw to release the mini door, and take it away.
2. Disconnect the two wireless cables.
3. Then take the wireless board from the base.



### ***Disassemble the RAM and ODD***

1. Remove the one screw to release the RAM door and remove it.
2. Press down the both side latches to release the RAM board.
3. Remove the one screw to release the ODD module.
4. Then push the inner position to remove the ODD from the base.
5. Pull the entire ODD module from the system.





### ***Disassemble the Middle Cover Board***

1. Remove the one screw.
2. Detach the middle cover from the unit with the flat screw driver.
3. Disconnect the system cable from the middle cover board.
4. Remove the two screws to release the middle cover board.
5. Then detach the middle cover board from cover.



### ***Disassemble the Keyboard***

1. Remove the screws on each side.
2. Pull up both sides of the latches to disconnect the FFC from the mainboard.
3. Remove the screws on each side to release the keyboard bracket.
4. Then take the keyboard supporter bracket from the system.

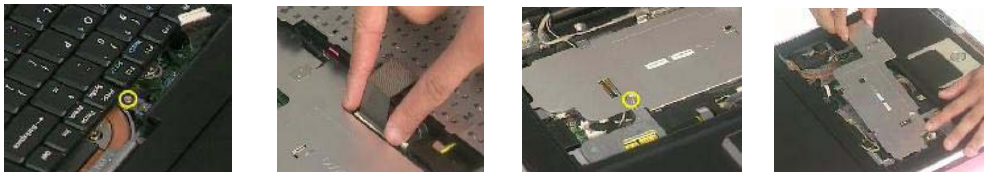

---

## ***Disassemble the LCD***

1. Remove the one screw from the LVDS board.
2. Pull the LCD coaxial board and the cable from the system.
3. Remove the two screws from the hinge on each side to release the LCD panel.
4. Pull the entire LCD module from the system.



## ***Disassemble the MDC and RAM***

1. Remove the two screws to release the MDC board.
2. Disconnect the MDC cable before you take the MDC board.
3. Press down the both sides latches to release the RAM.
4. Disconnect the right and left speaker cables from the mainboard.
5. Disconnect the touchpad FPC connector and CPU fan cable.



## ***Disassemble the Upper Case***

1. Remove the thirteen screws located on the base case.
2. Remove the two screws on the other side to located on the rear panel.
3. Remove the three screws to release the upper case.
4. Detach the upper case from the system.



---

## ***Disassemble the Main Unit ( Touchpad, Bluetooth and LCM Board)***

1. Remove the seven screws to release the touchpad supporter bracket.
2. Disconnect the touchpad FPC connector.
3. Disconnect the cable as highlights.
4. Then detach the touchpad bracket from the position.
5. Detach the touchpad PC from the module.
6. Disconnect the bluetooth board FFC connector.
7. Remove the two screws to release the bluetooth board.
8. Take the bluetooth board from the system.
9. Remove the one screw to release the LCM board.
10. Detach the LCM board from the system.

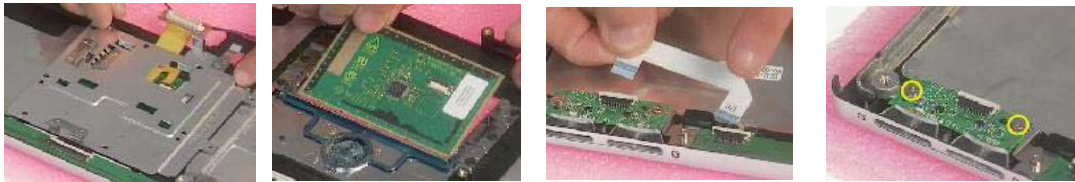



---

## ***Disassemble the Main Unit ( Speakers, Fan, Thermal and CPU)***

1. Remove the one screw to release the up hinge saddle.
2. Remove the three screws to release the bottom hinge saddle.
3. Detach the right hinge saddle from the case.
4. Remove the two screws to release the right hinge saddle.
5. Take the right speaker from the oposition.
6. Remove the one screw to release the CPU fan from the hinge saddle.
7. Take the CPU fan from the hinge saddle.

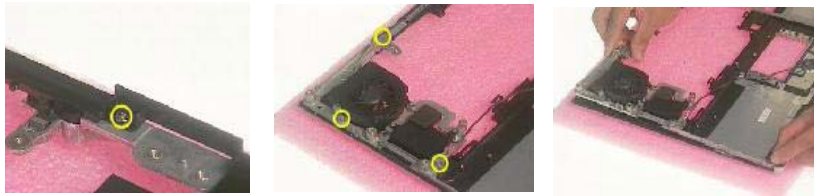

8. Remove the three screws to release the left hinge saddle.
9. Detach the left hinge saddle from the system.
10. Remove the one screw to release the left speaker from the base cover.
11. Then detach the left speaker.
12. Remove the four screws to release the thermal module.
13. Detach the thermal module from the system.
14. Remove the one screw to release the CPU.
15. Detach the CPU fan from the socket.

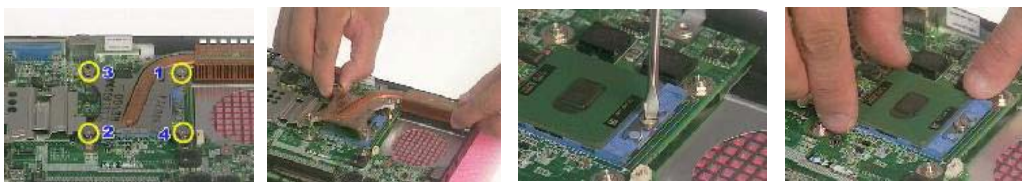
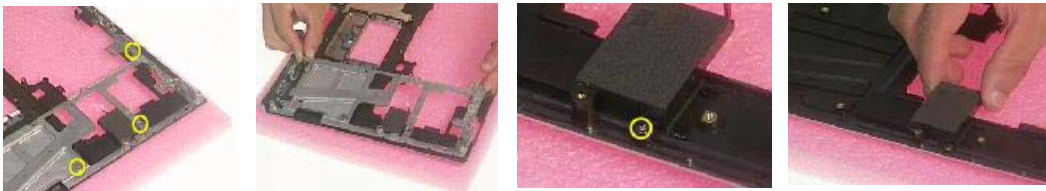

---

## ***Disassemble the Main Unit ( VGA, Card Reader, Sub-Woofer and Mainboard)***

1. Remove the one screw to release the VGA bracket.
2. Detach the VGA module from the mainboard.
3. Separate the VGA bracket and the VGA board.



4. Remove the ground screw to release the card reader.
5. Disconnect the card reader cables on each side.
6. Disconnect the sub-woofer cable
7. Remove the screws on each side to release the sub-woofer.
8. Detach the sub-woofer from the case.
9. Detach the card reader board from the case.



10. Remove the one screw to release the mainboard.
11. Press the PCMCIA button and hold the position to release the mainboard from the case.



---

## ***Disassemble the LCD Module***

1. Remove the screws on each side.
2. Detach the bezel from the LCD panel.
3. Remove the screws located on the different side.
4. Detach the LCD panel from the cover.
5. Take the antenna away from the position to release the inverter board.
6. Disconnect the LCD coaxial cables.
7. Remove the four screws to release the left LCD bracket.
8. Take the left LCD bracket from the panel.
9. Remove the four screws to release the right LCD bracket.
10. Take the right LCD bracket from the panel.



---

## ***Disassemble the ODD Module***

1. Remove the two screws to separate the ODD drive.
2. Detach the ODD bracket.
3. Detach the ODD door.



## ***Disassemble the HDD Module***

1. Remove the two screws on each side.
2. Separate the hard disk top cover and take the hard drive from the carrier.
3. Remove the hard disk connector from the rear position.



## Troubleshooting

Use the following procedure as a guide for computer problems.

1. Obtain the failed symptoms in as much detail as possible.
2. Verify the symptoms by attempting to re-create the failure by running the diagnostic test or by repeating the same operation.
3. If any problem occurs, you can perform visual inspection before you follow this chapter's instructions.

You can check the following:

- power cords are properly connected and secured;
- there are no obvious shorts or opens;
- there are no obviously burned or heated components;
- all components appear normal.

4. After you perform visual inspection you can also verify the following:
  - ask the user if a password is registered and, if it is, ask him or her to enter the password.
  - verify with the customer that Windows XP is installed on the hard disk. Operating systems that were not preinstalled by Acer can cause malfunction.
  - make sure all optional equipment is removed from the computer.
  - make sure the floppy disk is empty.
5. Use the following table with the verified symptom to determine which page to go to.

Symptoms (Verified)	Go To
Power failure. (The power indicator does not go on or stay on.)	"Power System Check"
POST does not complete. No beep or error codes are indicated.	"Insyde MobilePro BIOS POST Beep Code and POST Messages" "Undetermined Problems"
POST detects an error and displayed messages on screen.	"Insyde MobilePro BIOS POST Beep Code and POST Messages"
Other symptoms (i.e. LCD display problems or others).	"Insyde MobilePro BIOS POST Beep Code and POST Messages"
Symptoms cannot be re-created (intermittent problems).	Use the customer-reported symptoms and go to "Insyde MobilePro BIOS POST Beep Code and POST Messages" on page 67 "Intermittent Problems" "Undetermined Problems"

---

# ***System Check Procedures***

## ***External Diskette Drive Check***

Do the following steps to isolate the problem to a controller, driver, or diskette. A write-enabled, diagnostic diskette is required.

**NOTE:** Make sure that the diskette does not have more than one label attached to it. Multiple labels can cause damage to the drive or cause the drive to fail.

Do the following to select the test device.

1. The FDD heads can become dirty over time, affecting their performance. Use an FDD cleaning kit to clean the heads. If the FDD still does not function properly after cleaning, go to next step.
2. Boot from diagnostic program.
3. If an error occurs with the internal diskette drive, reconnect the diskette connector on the main board.

If the error still remains:

1. Reconnect the external diskette drive module.
2. Replace the external diskette drive module.
3. Replace the main board.

## ***External CD-ROM/DVD-ROM Drive Check***

Do the following to isolate the problem to a controller, drive, or CD-ROM/DVD-ROM. Make sure that the CD-ROM does not have any label attached to it. The label can cause damage to the drive or can cause the drive to fail.

Do the following to select the test device:

1. Insert an audio CD into the CD/DVD drive. If the CD/DVD drive can read the data from the audio CD. The drive does not have problem, then go to next step. If the CD/DVD LED on the front panel does not emit light as it read the data from the audio CD, then go to next step. However, if the CD/DVD drive can not read data from the audio CD, you may need to clean the CD/DVD drive with a CD/DVD drive cleaning disk.
2. Make sure that the appropriate driver has been installed on the computer for the CD/DVD drive.
3. Boot from the diagnostics diskette and start the diagnostics program
4. See if CD-ROM Test is passed when the program runs to CD-ROM/DVD-ROM Test.
5. Follow the instructions in the message window.

If an error occurs, reconnect the connector on the main board. If the error still remains:

1. Reconnect the CD-ROM/DVD-ROM module.
2. Replace the CD-ROM/DVD-ROM module.
3. Replace the main board.

---

## ***Keyboard or Auxiliary Input Device Check***

Remove the external keyboard if the internal keyboard is to be tested.

If the internal keyboard does not work or an unexpected character appears, make sure that the flexible cable extending from the keyboard is correctly seated in the connector on the main board.

If the keyboard cable connection is correct, run the Keyboard Test.

If the tests detect a keyboard problem, do the following one at a time to correct the problem. Do not replace a non-defective FRU:

1. Reconnect the keyboard cables.
2. Replace the keyboard.
3. Replace the main board.

The following auxiliary input devices are supported by this computer:

- Embedded Numeric Keypad
- External keyboard

If any of these devices do not work, reconnect the cable connector and repeat the failing operation.

## ***Memory Check***

Memory errors might stop system operations, show error messages on the screen, or hang the system. Currently, we do not provide memory test program. However, if you need to check memory but have no testing program or diagnostic utility at hand, please go to <http://www.passmark.com> to download the shareware "BurnIn Test V.3.0". You may test the memory with this program under Window XP environment.

**NOTE:** Make sure that the DIMM is fully installed into the connector. A loose connection can cause an error.

## ***Power System Check***

To verify the symptom of the problem, power on the computer using each of the following power sources:

1. Remove the battery pack.
2. Connect the power adapter and check that power is supplied.
3. Disconnect the power adapter and install the charged battery pack; then check that power is supplied by the battery pack.

If you suspect a power problem, see the appropriate power supply check in the following list:

- "Check the Power Adapter"
- "Check the Battery Pack"

---

## Check the Power Adapter

Unplug the power adapter cable from the computer and measure the output voltage at the plug of the power adapter cable. See the following figure

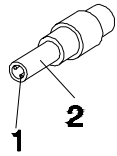

Pin 1: 19V  
Pin 2: 0V, Ground

1. If the voltage is not correct, replace the power adapter.
2. If the voltage is within the range, do the following:
  - Replace the main board.
  - If the problem is not corrected, see “Undetermined Problems”.
  - If the voltage is not correct, go to the next step.

**NOTE:** An audible noise from the power adapter does not always indicate a defect.

3. If the DC-IN indicator does not light up, check the power cord of the power adapter for correct continuity and installation.
4. If the operational charge does not work, see “Check the Power Adapter” .



---

## ***Check the Battery Pack***

To check the battery pack, do the following:

From Software:

1. Check out the Power Options in control Panel
2. In Power Meter, confirm that if the parameters shown in the screen for Current Power Source and Total Battery Power Remaining are correct.
3. Repeat the steps 1 and 2, for both battery and adapter.
4. This helps you identify first the problem is on recharging or discharging.

From Hardware:

1. Power off the computer.
2. Remove the battery pack and measure the voltage between battery terminals 1(+) and 6(ground).
3. If the voltage is still less than 7.5 Vdc after recharging, replace the battery.
4. If the voltage is within the normal range, run the diagnostic program.

To check the battery charge operation, use a discharged battery pack or a battery pack that has less than 50% of the total power remaining when installed in the computer.

If the battery status indicator does not light up, remove the battery pack and let it return to room temperature. Re-install the battery pack.

If the charge indicator still does not emit, replace the battery pack. If the charge indicator still does not light up, replace the DC/DC charger board.

## ***Touchpad Check***

If the touchpad doesn't work, do the following actions one at a time to correct the problem. Do not replace a non-defective FRU:

1. After rebooting, run Touch pad/PS2 Mode Driver.
2. Run utility with the PS/2 mouse function and check if the mouse is working.
3. If the PS/2 mouse does not work, then check if the main board to switch board FPC is connected well.
4. If the main board to switch board FPC is connected well, then check if the touch pad FPC connects to the main board properly.
5. If there is still an error after you have connected the touch pad FPC to the main board properly, then replace the touch pad or touch pad FPC. The touch pad or touch pad FPC may be damaged.
6. Replace switch board.
7. If the touch pad still does not work, then replace the FPC on Track Pad PCB.

After you use the touchpad, the pointer drifts on the screen for a short time. This self-acting pointer movement can occur when a slight, steady pressure is applied to the touchpad pointer. This symptom is not a hardware problem. No service actions are necessary if the pointer movement stops in a short period of time.

## ***Display Check***

1. Connect an external display to the computer's external monitor port, the boot the computer. The computer can automatically detect the external display. Press Fn+  to switch to the external display.
2. If the external display works fine, the internal LCD may be damaged. Then perform the following steps:

Make sure the DDRRAM module is seated properly. Then run the display test again. If the problem still exists, go to next step.

Replace the inverter board, then run the display test program again. If the problem still occurs, go on next step.

Replace the LCD module with a new one then run the display test again. If the problem still happens, continue next step.

Replace LCD/FL cable with a new one then execute the display diagnostic again. If the problem

---

still occurs, continue next step.

Replace the CPU with another of the same specifications. If the problems still occurs, go to next step.

The main board may be damaged. Replace main board.

3. If the external monitor has the same problem as the internal monitor, the main board may be damaged. Please insert the diagnostic disk and run the display test program and go through the sub-steps under step 2.

## ***Sound Check***

To determine if the computer's built-in speakers are functioning properly, perform the following steps. Before you start the steps below, adjust the speaker volume to an appropriate level.

1. Try different audio sources. For example, employ audio CD and digital music file to determine whether the fault is in the speaker system or not. If not all sources have sound problem, the problem is in the source devices. If all have the same problem, continue next step.
2. Connect a set of earphone or external speakers. If these devices work fine, go to next step. If not, then the main board may be defective or damaged. Replace the main board.
3. Follow the disassembling steps in Chapter 3. Ensure the speaker cable is firmly connected to the main board. If the speaker is still a malfunction, go on next step.
4. If the speakers do not sound properly, the speakers may be defective or damaged. Replace the speakers. If the problem still occurs, then replace the main board.

## ***Insyde MobilePro BIOS POST Beep Code and POST Messages***

The POST error message index lists the error message and their possible causes. The most likely cause is listed first.

**NOTE:** Perform the FRU replacement or actions in the sequence shown in FRU/Action column, if the FRU replacement does not solve the problem, put the original part back in the computer. Do not replace a non-defective FRU.

This index can also help you determine the next possible FRU to be replaced when servicing a computer.

If the symptom is not listed, see “Undetermined Problems” on page 73.

The following lists the error messages that the BIOS displays on the screen and the error symptoms classified by function.

**NOTE:** Most of the error messages occur during POST. Some of them display information about a hardware device, e.g., the amount of memory installed. Others may indicate a problem with a device, such as the way it has been configured.

**NOTE:** If the system fails after you make changes in the BIOS Setup Utility menus, reset the computer, enter Setup and install Setup defaults or correct the error.

<b>Beep Code</b>	<b>Message</b>	<b>Description</b>
short, short, short; short, short, long	“FAULTY DMA PAGE REGISTERS”	DMA page registers do not function properly.
short, short, short; short, long, short	“FAULTY REFRESH CIRCUIT”	RAM refresh circuit does not function properly.
short, short, short; short, long, long	“ROM CHECKSUM INCORRECT”	BIOS ROM checksum failed.
short, short, short; long, short, short	“CMOS RAM TEST FAILED”	CMOS RAM test failed.
short, short, short; long, short, long	“DMA CONTROLLER FAULTY”	DMA controller does not work properly.
short, short, short; long, long short	“INTERRUPT CONTROLLER FAILED”	The interrupt controller does not work properly.
short, short, short; long, long, long	N/A	Keyboard controller failed to respond with the self-test command.
short, short, long; short, short, short	N/A	No video device found.
short, short, long; short, short, long	N/A	No RAM installed.
N/A	“KEYBOARD CONTROLLER FAILURE”	Keyboard controller failed during system inquiry about connected devices.
N/A	“KEYBOARD FAILURE”	The keyboard fails to respond or no keyboard is connected.
N/A	“CMOS FAILURE - RUN SCU”	CMOS data error, probably due to battery power loss.
N/A	“CMOS CHECKSUM INVALID - RUN SCU”	CMOS checksum error.
N/A	“RAM ERROR AT LOCATION xxxxxx: WROTE: xxxx READ: xxxx”	The RAM failed during memory test at the indicated location.

Beep Code	Message	Description
N/A	"PARITY ERROR AT UNKNOWN LOCATION"	Parity error during memory test at unknown location.
N/A	"PARITY ERROR AT LOCATION XXXXXX"	Parity error during memory test at the indicated location.
N/A	"NO INTERRUPTS FROM TIMER 0"	Timer 0 of the clock timer controller does not generate system interrupts correctly.
N/A	"UNEXPECTED AMOUNT OF MEMORY - RUN SCU"	The system memory size does not match with the CMOS record.
N/A	"CLOCK NOT TICKING CORRECTLY"	The system clock does not working correctly.
N/A	"TIME/DATA CORRUPT - RUN SCU"	The time/date information in CMOS is invalid.
N/A	"MACHINE IS LOCKED - TURN KEY"	The keyboard operation is locked.
N/A	"BOOT SECTOR 0 HAS CHANGED"	The boot sector of the hard disk has been changed, probably because of a virus attack.
N/A	Suspend-to-Disk partition MISSING!"	No Suspend-to-Disk partition found.
N/A	"Hard Disk ERROR!"	Access to the Suspend-to-Disk partition failed.
N/A	"Suspend-to-Disk partition signature NOT FOUND!"	No Suspend-to-Disk partition signature found.
N/A	"Suspend-to-Disk partition size TOO SMALL!"	The capacity of the Suspend-to-Disk partition is not enough.
N/A	"MEMORY SIZE HAS CHANGED -- REBOOTING"	The memory size has changed after previous Suspend-to-Disk operation.

# Index of Symptom-to-FRU Error Message

## LCD-Related Symptoms

Symptom / Error	Action in Sequence
LCD backlight doesn't work LCD is too dark LCD brightness cannot be adjusted LCD contrast cannot be adjusted	Enter BIOS Utility to execute "Load Setup Defaults" on Exit screen, then reboot system. Reconnect the LCD connectors. Keyboard (if contrast and brightness function key doesn't work). LCD cable LCD inverter LCD Main board
Unreadable LCD screen Missing pels in characters Abnormal screen Wrong color displayed	Reconnect the LCD connector LCD cable LCD inverter LCD Main board
LCD has extra horizontal or vertical lines displayed.	LCD inverter LCD cable LCD Main board

## Indicator-Related Symptoms

Symptom / Error	Action in Sequence
Indicator incorrectly remains off or on, but system runs correctly	Reconnect the inverter board Inverter board Main board

## Power-Related Symptoms

Symptom / Error	Action in Sequence
Power shuts down during operation	Power source (battery pack and power adapter). See "Power System Check" . Battery pack Power adapter Hard drive & battery connection board Main board
The system doesn't power-on.	Power source (battery pack and power adapter). See "Power System Check" . Battery pack Power adapter Hard drive & battery connection board Main board
The system doesn't power-off.	Power source (battery pack and power adapter). See "Power System Check" . Hold and press the power switch for more than 4 seconds. Main board
Battery can't be charged	See "Check the Power Adapter". Battery pack Main board

### PCMCIA-Related Symptoms

Symptom / Error	Action in Sequence
System cannot detect the PC Card (PCMCIA)	PCMCIA slot assembly Main board
PCMCIA slot pin is damaged.	PCMCIA slot assembly

### Memory-Related Symptoms

Symptom / Error	Action in Sequence
Memory count (size) appears different from actual size.	DIMM Main board

### Speaker-Related Symptoms

Symptom / Error	Action in Sequence
In Windows, multimedia programs, no sound comes from the computer.	See "Sound Check" on page 66 Audio driver Speaker Main board
Internal speakers make noise or emit no sound.	See "Sound Check" on page 66 Speaker Main board

### Power Management-Related Symptoms

Symptom / Error	Action in Sequence
The system will not enter hibernation	Keyboard (if control is from the keyboard) Hard disk drive Main board
The system doesn't enter hibernation mode and four short beeps every minute.	Press Fn+F4 and see if the computer enters hibernation mode. Touchpad Keyboard Hard disk connection board Hard disk drive Main board
The system doesn't enter standby mode after closing the LCD	LCD cover switch Main board
The system doesn't resume from hibernation mode.	Hard disk connection board Hard disk drive Main board
The system doesn't resume from standby mode after opening the LCD.	LCD cover switch Main board
Battery fuel gauge in Windows doesn't go higher than 90%.	Remove battery pack and let it cool for 2 hours. Refresh battery (continue use battery until power off, then charge battery). Battery pack Main board

### Power Management-Related Symptoms

Symptom / Error	Action in Sequence
System hangs intermittently.	Reconnect hard disk drives. Hard disk drive connector Main board

### Peripheral-Related Symptoms

Symptom / Error	Action in Sequence
System configuration does not match the installed devices.	Enter BIOS Setup Utility to execute "Load Setup defaults", then reboot system. Reconnect hard disk/CD-ROM/diskette drives.
External display does not work correctly.	See if there is an error beep. If there is an error beep, then change main board. Power off. Then check if RAM CPU BIOS are well-connected. Press Fn+F5 three times slowly LCD FPC LCD inverter LCD
USB does not work correctly	USB device cable is firmly connected into the USB ports. Test one USB port each time. USB socket is firmly secured to the main board. Main board
Print problems.	Ensure the "Parallel Port" in the "System Devices" of BIOS Setup Utility is set to Enabled. Onboard Devices Configuration Run parallel port test Printer driver Printer cable Printer Main board

### Keyboard/Touchpad-Related Symptoms

Symptom / Error	Action in Sequence
Keyboard (one or more keys) does not work.	Reconnect the keyboard cable. Keyboard Main board
Touchpad does not work.	Reconnect touch pad cable. Modem port is secured to the main board Touch pad FPC Audio/Touch pad board Main board

---

### Modem-Related Symptoms

Symptom / Error	Action in Sequence
Internal modem does not work correctly.	Ensure the telephone cable is firmly plugged into the telephone wall socket and the modem port of the computer. Modem phone port is secured to the main board. modem combo board Main board



---

## ***Intermittent Problems***

Intermittent system hang problems can be caused by a variety of reasons that have nothing to do with a hardware defect, such as: cosmic radiation, electrostatic discharge, or software errors. FRU replacement should be considered only when a recurring problem exists.

When analyzing an intermittent problem, do the following:

1. Run the diagnostic test for several times to isolate the problem.
2. If no error is detected, do not replace any FRU.
3. If any error is detected, replace the FRU. Rerun the test to verify that there are no more errors.

---

## ***Undetermined Problems***

The diagnostic problems does not identify which adapter or device failed, which installed devices are incorrect, whether a short circuit is suspected, or whether the system is inoperative.

Follow these procedures to isolate the failing FRU (do not isolate non-defective FRU).

**NOTE:** Verify that all attached devices are supported by the computer.

1. Power-off the computer.
2. Visually check them for damage. If any problems are found, replace the FRU.
3. Remove or disconnect all of the following devices:
  - Non-Acer devices
  - Printer, mouse, and other external devices
  - Battery pack
  - Hard disk drive
  - DIMM
  - CD-ROM/Diskette drive Module
  - PC Cards
4. Power-on the computer.
5. Determine if the problem has changed.
6. If the problem does not recur, reconnect the removed devices one at a time until you find the failing FRU.
7. If the problem remains, replace the following FRU one at a time. Do not replace a non-defective FRU:
  - Main board
  - LCD assembly

---

## ***How to Build NAPP Master Hard Disc Drive***

### ***CD to Disk Recovery***

1. Prepare NAPP CD, Recovery CD and System CD.
2. Insert the NAPP CD into the optical drive. Then boot up the system.
3. The system will ask you if you want to build NAPP Master HDD. Please press any key to continue.

```
=====
                        The HDD Must bigger then 20GB.
=====
Do you want to build NAPP Master HDD?
press any key to continue or Ctrl-C to exit
_
```

4. NAPP CD will start to preload the system, please click [Y].

```
Acer NAPP Preload Selector for Acer System Version 1.4.0.1
Copyright 2003 Acer Inc.
=====
This will preload your system. Are you sure?[Y,N]?
```

- 
5. Select CD to Disk Recovery.

```
Method Selector
=====
1. Disk To Disk Recovery
2. CD to Disk Recovery
X. Quit

Please select your Choose...[1,2,x]?
```

6. Put the Recovery CD to the optical drive. This step is to create image files to the system, you do not have to put the Recovery CD to the optical drive in order. Place one Recovery CD to the drive at one time till you finish all Recovery CDs.

```
Please Insert Any Recovery CD

Please Press Any Key to Continue.
Press any key to continue...
_
```

After you place the Recovery CD to the optical drive, you will see the display below.

---

```
Please Wait for COPYING .....  
X:\images \70E40101.HDD
```

7. Then insert the System CD to the optical drive.

```
Please Insert the System CD  
  
Please Press Any Key to Continue.  
Press any key to continue...  
_
```

8. You will see the screen displaying "PASS" when the system has built NAPP Master hard disc drive.

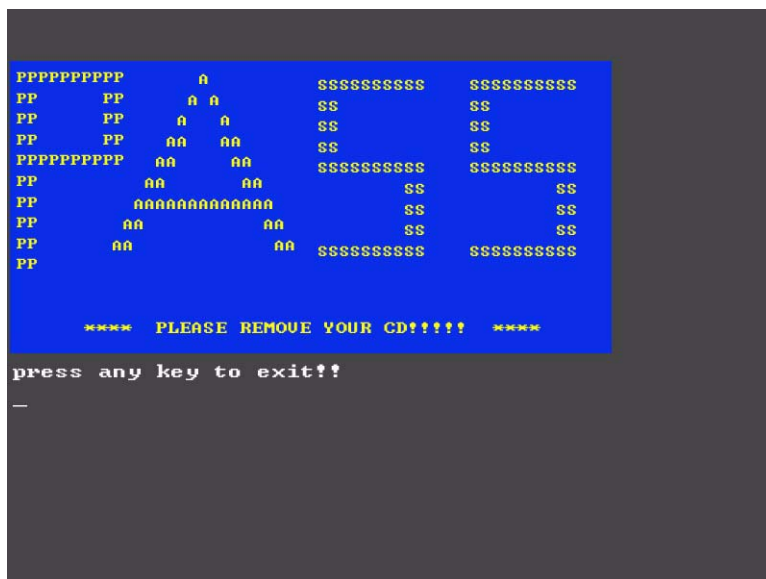

## ***Disk to Disk Recovery***

1. Prepare NAPP CD, Recovery CD and System CD.
2. Put NAPP CD into the optical drive. Then boot up the system.
3. The system will ask you if you want to build NAPP Master HDD. Please press any key to continue.



- 
4. NAPP CD will start to preload the system, please click [Y].

```
Acer NAPP Preload Selector for Acer System Version 1.4.0.1
Copyright 2003 Acer Inc.

=====

This will preload your system. Are you sure?[Y,N]?
```

5. Select Disk to Disk Recovery. Then choose Single Language or Multi-Languages Recovery.  
**NOTE:** For Multi-Languages Recovery, not more than five languages could be loaded to the system.

```
Method Selector
=====
1. Single Language Recovery
2. Multi-Languages Recovery
X. Quit

Please select your Choose...[1,2,x]?
```

- 
- Put the Recovery CD to the optical drive. This step is to create image files to the system, you do not have to put the Recovery CD to the optical drive in order. Place one Recovery CD to the drive at one time till you finish all Recovery CDs.

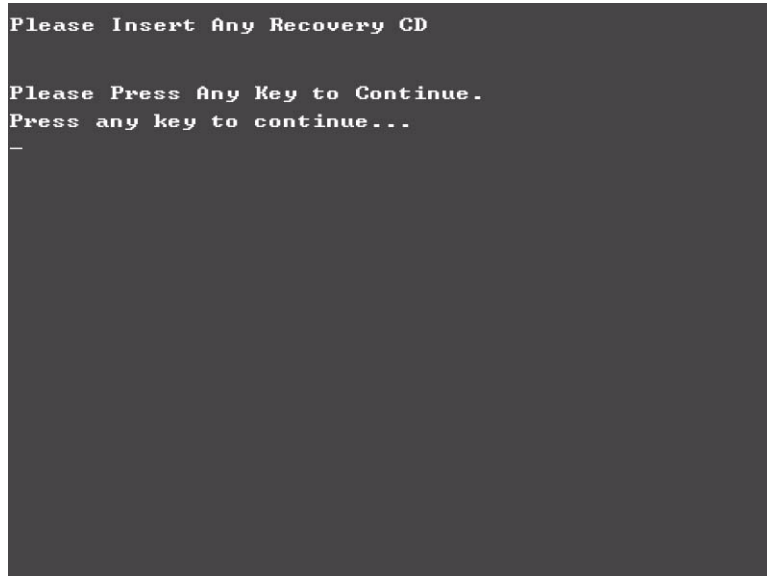

After you place the Recovery CD to the optical drive, you will see the display below.





7. Then insert the System CD to the optical drive.

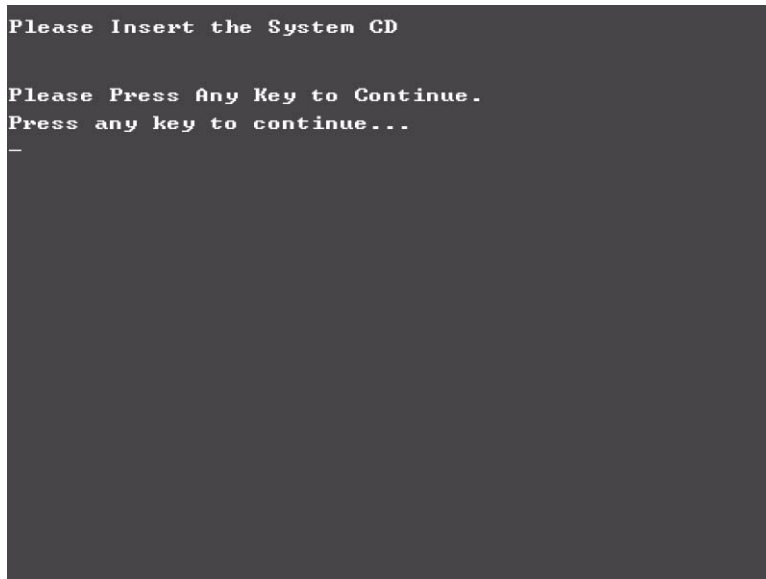

8. You will see the screen displaying “PASS” when the system has buit NAPP Master hard disc drive.

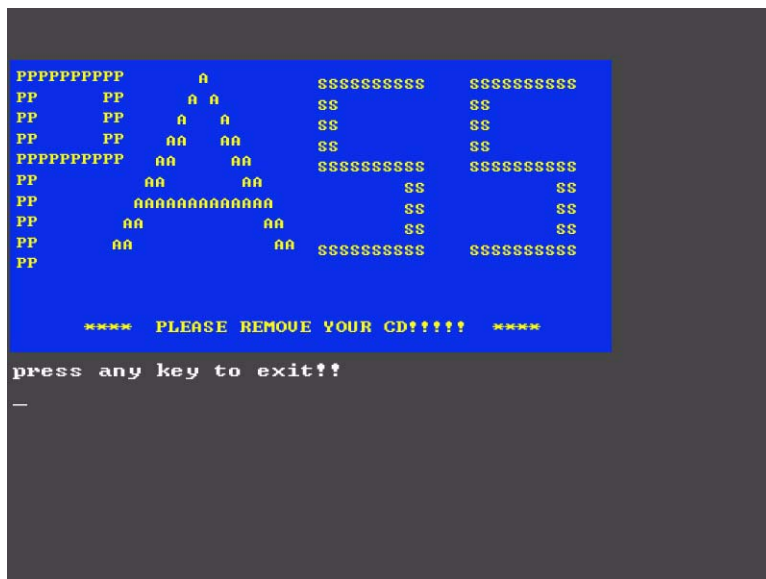

## Jumper and Connector Locations

### Top View

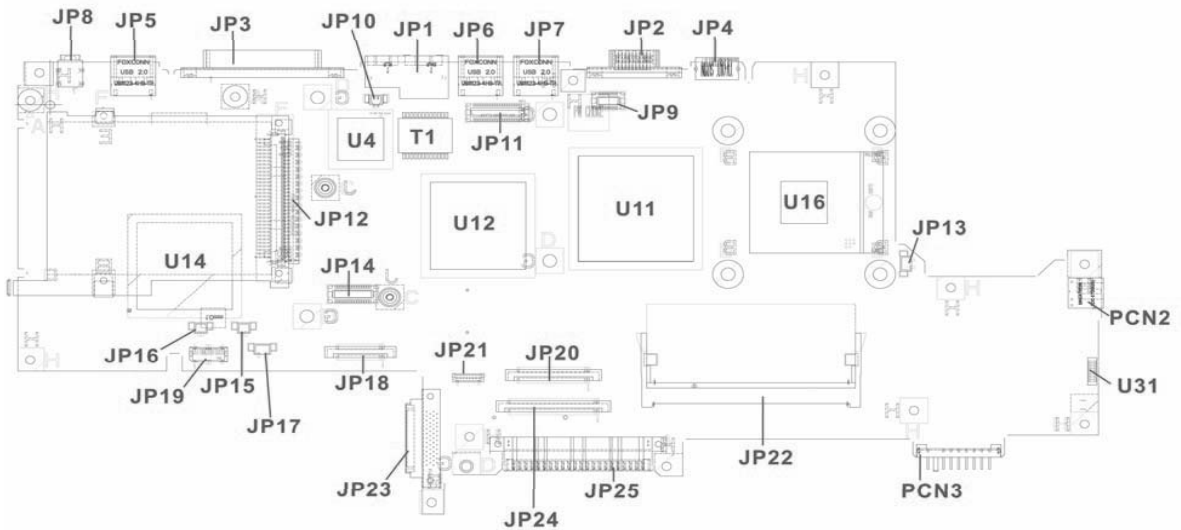

Item	Description
JP1	RJ11/RJ45 Connector
JP2	CRT Connector
JP3	Printer Connector
JP4	TV-Out Connector
JP5/6/7	USB Connector
JP8	IEEE 1394 Connector
JP9	Power Board Connector
JP10	MDC Cable Connector
JP11	LCD Connector
JP12	Cardbus Connector
JP13	FAN Connector
JP14	MDC Connector
JP15	Right Speaker Connector
JP16	Left Speaker Connector
JP17	Subwoofer Connector
JP18	LCM Connector
JP19	SD Board Connector
JP20	Int. K/B Connector
JP21	Bluetooth Connector
JP22	DDR SODIMM Socket
JP23	ODD Speaker

---

Item	Description
JP24	T/P Board Connector
JP25	HDD Connector
PCN2	AC Jack
PCN3	Battery Connector

# Bottom View

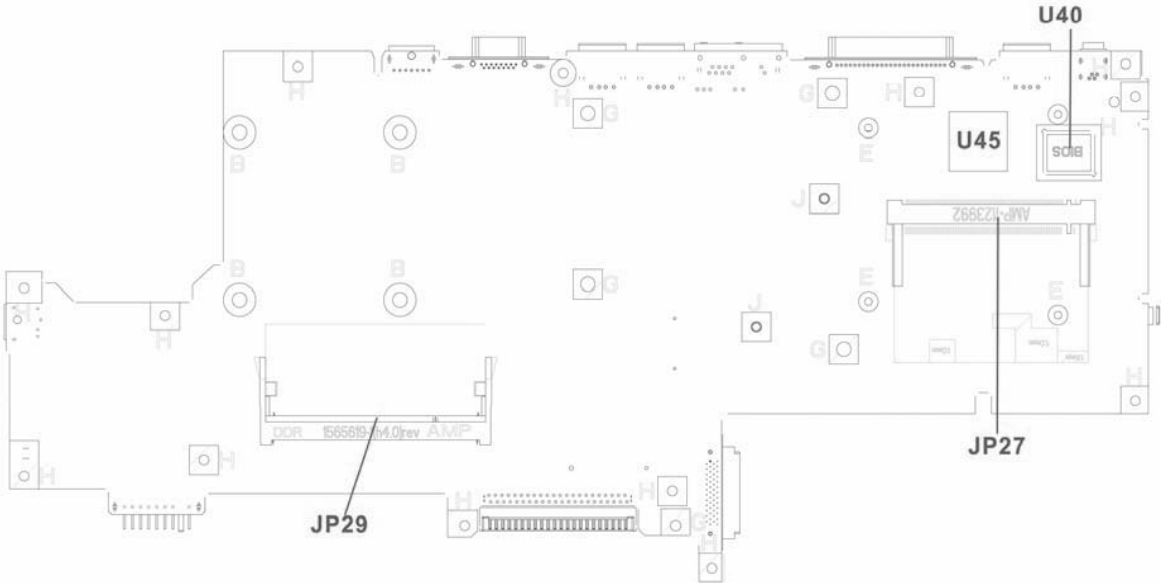

Item	Description
JP27	Mini-PCI Connector
JP29	DDR SODIMM Socket
U40	BIOS ROM
U45	Cardbus Controller

# Power Board

## Top View

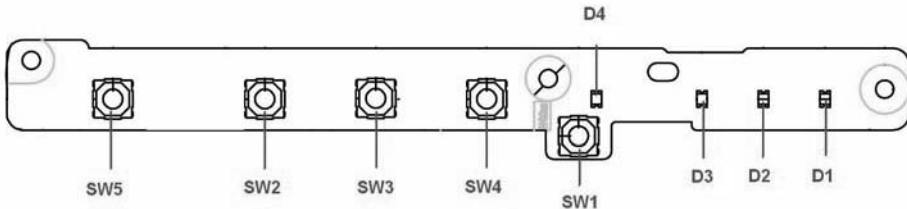

## Rear View

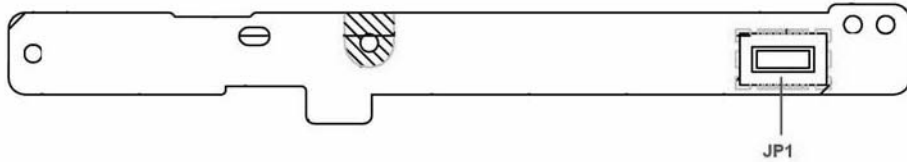

Item	Description
SW5	Power Button
SW2	User Button 1
SW3	User Button 1
SW4	Internet Bottom
SW1	E-Mail Bottom
JP1	To M/B Connector
D1	Scroll Lock LED
D2	Num Lock LED
D3	Caps Lock LED
D4	E-Mail LED

# T/P Board

## Top View

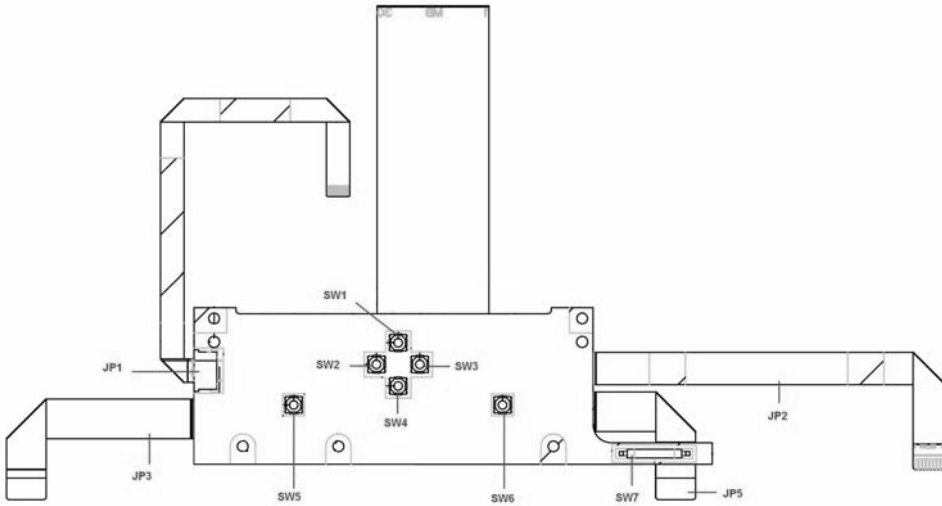

## Rear View

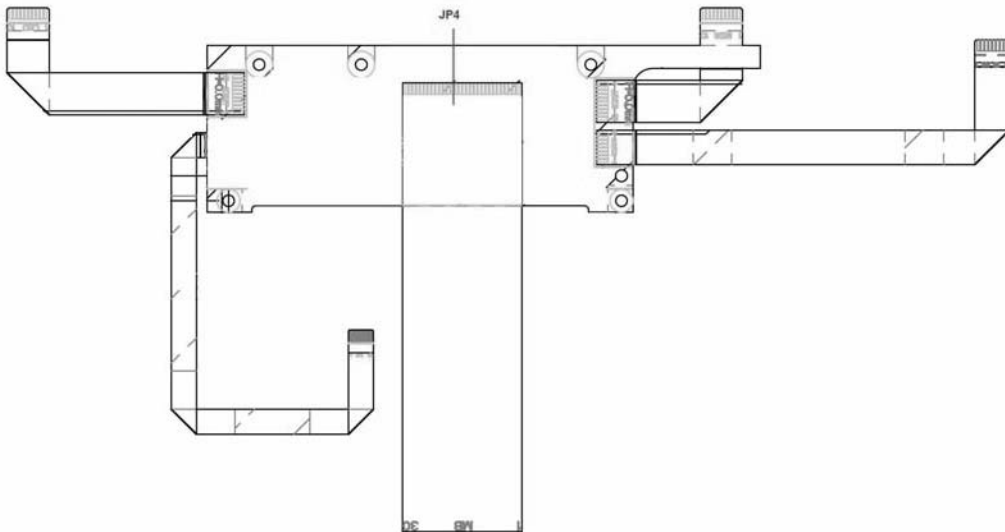

Item	Description	Item	Description
SW1	Scroll-Up Button	SW7	Lid Switch
SW2	Scroll-left Button	JP1	To Touch Pad Cable
SW3	Scroll-Right Button	JP2	To Button Board Cable

---

<b>Item</b>	<b>Description</b>	<b>Item</b>	<b>Description</b>
SW4	Scroll-Down Buttom	JP3	To LED Board Cable
SW5	Left Buttom	JP4	To M/B Cable
SW6	Right Buttom	JP5	To Media Board Cable

# SD Board

## Top View

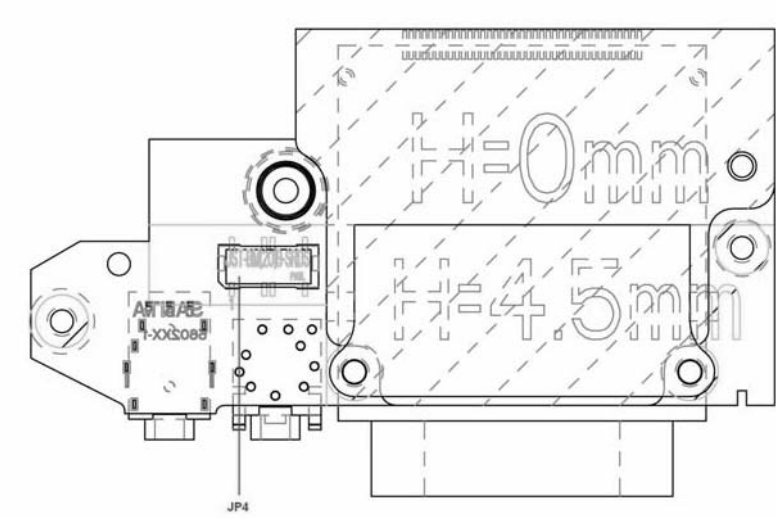

## Rear View

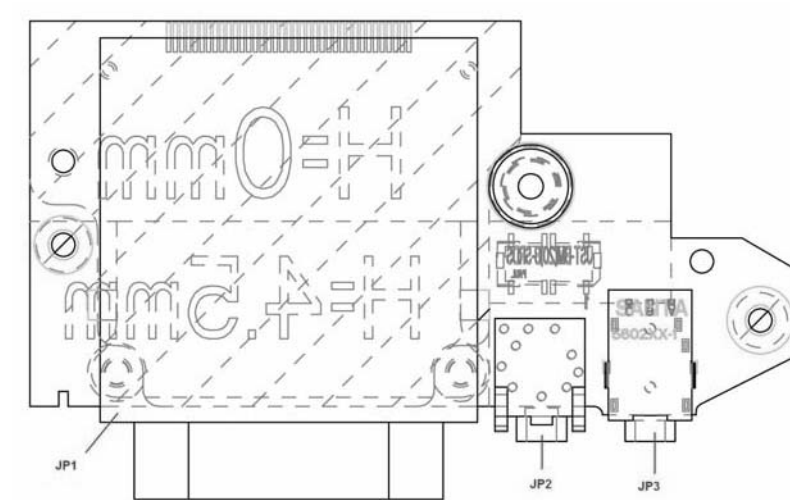

Item	Description
JP1	Card Reader Socket
JP2	MIC-In/Line-In Jack
JP3	SPDIF/Headphone-Out Jack
JP4	To M/B wire connector



# Media Board

## Top View

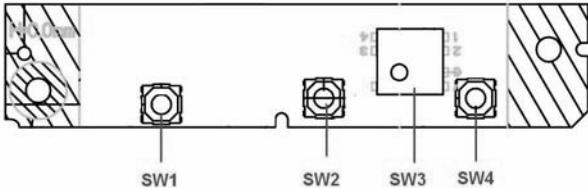

## Rear View

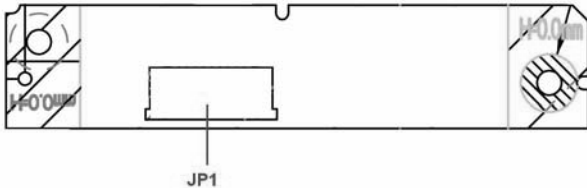

Item	Description
SW1	Stop Bottom
SW2	Backward Bottom
SW3	Media Control Bottom
SW4	Forward Bottom
JP1	To T/P Board Connector

# LED Board

## Top View

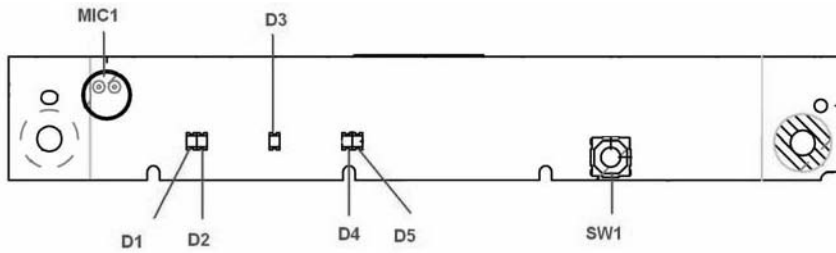

## Rear View

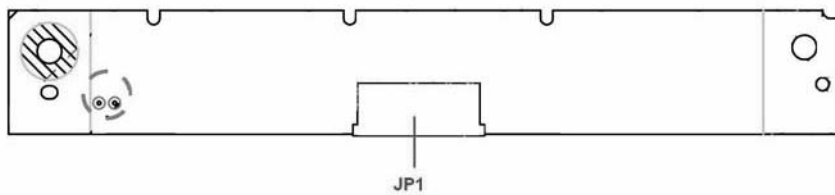

Item	Description
SW1	Arcade Bottom
JP1	To T/P Board Connector
D1/D2	Power Status LED
D3	Activity LED
D4/D5	Battery Status LED
MIC1	Internal Microphone

# Bottom Board

## Top View

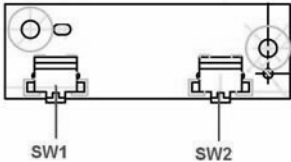

## Rear View

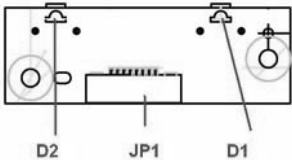

Item	Description
SW1	Bluetooth On/Off Bottom
SW2	Wireless On/Off Bottom
JP1	To T/P Board Connector
D1	Bluetooth Status LED
D2	Wireless Status LED

## ***FRU (Field Replaceable Unit) List***

---

This chapter gives you the FRU (Field Replaceable Unit) listing in global configurations of Aspire 2010/2020. Refer to this chapter whenever ordering for parts to repair or for RMA (Return Merchandise Authorization). Please also note that there are some common parts for Aspire 2000, yet the LCD modules are different in two model.

Please note that WHEN ORDERING FRU PARTS, you should check the most up-to-date information available on your regional web or channel. For whatever reasons a part number change is made, it will not be noted on the printed Service Guide. For ACER AUTHORIZED SERVICE PROVIDERS, your Acer office may have a DIFFERENT part number code from those given in the FRU list of this printed Service Guide. You MUST use the local FRU list provided by your regional Acer office to order FRU parts for repair and service of customer machines.

**NOTE:** To scrap or to return the defective parts, you should follow the local government ordinance or regulations on how to dispose it properly, or follow the rules set by your regional Acer office on how to return it.

# Exploded Diagram

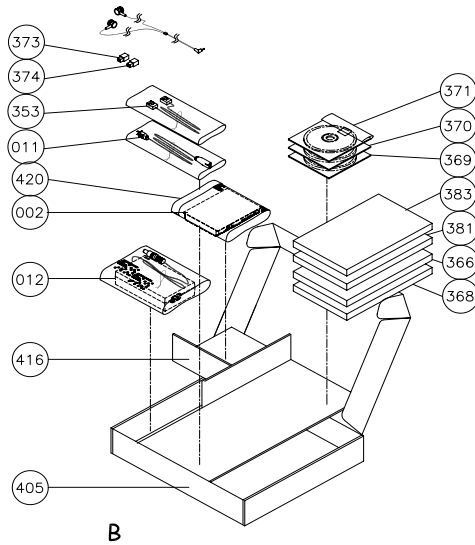
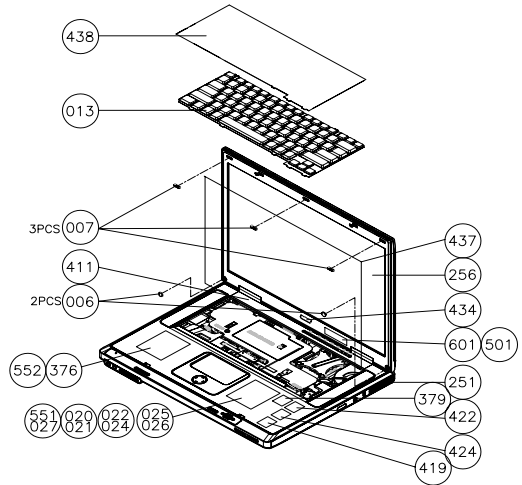
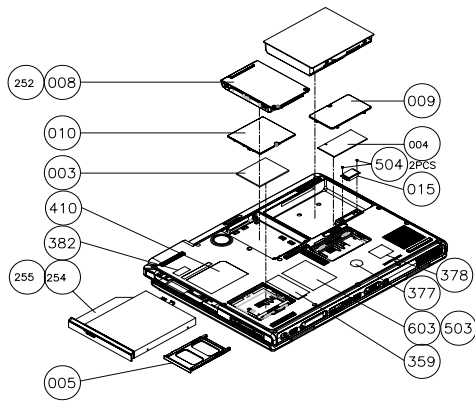

FOR USA/CANADA SKU--W/COMBO

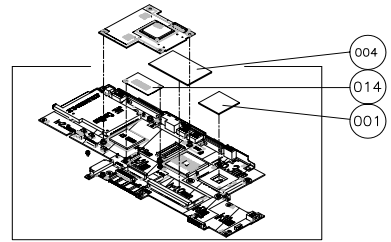
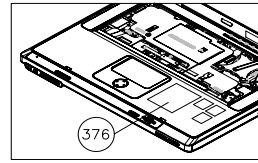

DFL32 640118B0011 PACKING (TEST)

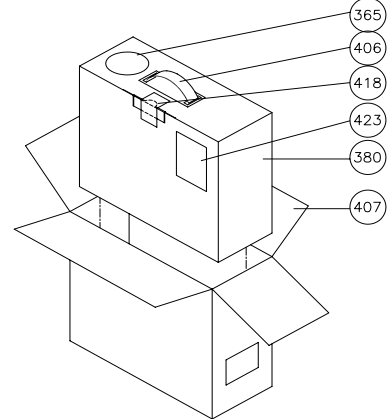
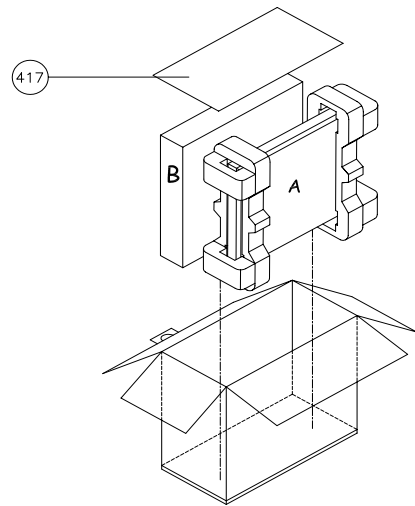
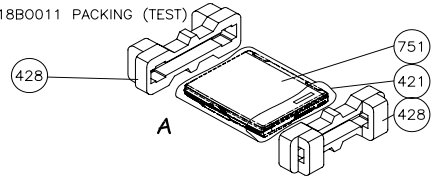

# Aspire 2010 Parts List

PHOTO	PARTNAME	ACER P/N
<b>ADAPTER</b>		
	ADAPTER W/LED-DELTA 65W ADP-65B	AP.T2101.001
	ADAPTER W/O LED-LITEON 65W PA-1650-02CR	AP.T3503.001
<b>BATTERY</b>		
	BATTERY LI-ION&CELLS-PANASONIC GC86503PAJ0	TBD
	BATTERY LI-ION&CELLS-SAMSUNG- GC86508SMG0	TBD
<b>BOARD</b>		
	MODEM BOARD AMBIT T60M283	54.A14V5.001
	MINI PCI WIRELESS BOARD (802.11b)INTEL	54.A14V5.002
	MINI PCI WIRELESS BOARD (802.11 b+g)	54.A24V5.001
	LAUNCH BOARD	55.A24V5.001
	WIRELESS & B/T SWITCH BOARD	55.A14V5.003

PHOTO	PARTNAME	ACER P/N
	LCM BOARD	55.A25V5.001
	LED BOARD	55.A25V5.002
	MEDIA BOARD	55.A25V5.003
	T/P BOARD W/4*FFC	55.A25V5.004
<b>CABLES</b>		
	CARD READER WIRE SET	50.A24V5.001
	MODEM CABLE	50.A24V5.002
	LCM TO MB FFC	50.A25V5.001
	TOUCHPAD FFC CABLE	50.A24V5.003
	POWER CORD US	27.A14V5.001
	POWER CORD EC	27.A14V5.002
	POWER CORD AUS	27.A14V5.003
	POWER CORD UK	27.A14V5.004
	POWER CORD SWISS	27.A14V5.005
	POWER CORD CHINA	27.A14V5.006
	POWER CORD ITALIAN	27.A14V5.007
	POWER CORD DENMARK	27.A14V5.008
<b>CASE/COVER/BRACKET ASSEMBLY</b>		

PHOTO	PARTNAME	ACER P/N
	MIDDLE COVER W/NAME PLATE	42.A25V5.001
	LOWER CASE ASSY	60.A25V5.001
	DIMM COVER	42.A14V5.002
	UPPER CASE ASSY W/O SPEAKER FAN HINGE SIDDLE	60.A14V5.002
	MINI PCI COVER	42.A14V5.003
	TOUCHPAD BRACKET	33.A24V5.001
	HINGE SADDLE -R	33.A14V5.008
	HINGE SADDLE-L	33.A14V5.009



PHOTO	PARTNAME	ACER P/N
	VGA PLATE W/THURMAL PAD	33.A24V5.002
<b>COMMUNICATION MODULE</b>		
	ANTENNA ASSY	50.A14V5.006
<b>COMBO DRIVE</b>		
	DVD/CDRW COMBO MODULE PANASONIC (SLOT IN) (CW-8123)	6M.A25V5.001
	DVD/CDRW COMBO DRIVE PANASONIC (SLOT IN) (CW-8123)	TBD
<b>CASE/COVER/BRACKET ASSEMBLY</b>		
	DVD/CDRW COMBO BEZEL FOR PANASONIC (SLOT IN)	42.A25V5.002
	OPTICAL DEVICE BRACKET	33.A14V5.004
<b>DVD RW DRIVE</b>		
	DVD SUPER MULTI MODULE MKE (SLOT IN)(UJ-825)	6M.A25V5.002
	DVD SUPER MULTI DRIVE MKE (SLOT IN)(UJ-825)	TBD
<b>CASE/COVER/BRACKET ASSEMBLY</b>		
	DVD SUPER MULTI BEZEL FOR MKE (SLOT IN)(UJ-825)	42.A25V5.003
	OPTICAL DEVICE BRACKET	33.A14V5.004
	HDD CARRIER	42.A14V5.007
	HDD CONNECTOR	20.A14V5.001
<b>KEYBOARD</b>		
	KEYBOARD ARABIC	KB.A1402.011
	KEYBOARD BELGIUM	KB.A1402.013
	KEYBOARD CHINESE	KB.A1402.005
	KEYBOARD CZECH	KB.A1402.015
	KEYBOARD DANISH	KB.A1402.018
	KEYBOARD FRENCH	KB.A1402.006
	KEYBOARD GERMAN	KB.A1402.003
	KEYBOARD ITALIAN	KB.A1402.004
	KEYBOARD NORWEGIAN	KB.A1402.017
	KEYBOARD PORTUGUESE	KB.A1402.010
	KEYBOARD SPANISH	KB.A1402.009
	KEYBOARD SWEDEN	KB.A1402.014
	KEYBOARD SWISS/G	KB.A1402.008
	KEYBOARD THAI	KB.A1402.012
	KEYBOARD UK	KB.A1402.002

PHOTO	PARTNAME	ACER P/N
	KEYBOARD US INTERNATIONAL	KB.A1402.001
	KEYBOARD HUNGAIAN	KB.A1402.016
	KEYBOARD CANADIAN FRENCH	KB.A1402.007
	KEYBOARD RUSSIAN	KB.A1402.019
<b>LCD SAMSUNG MODULE</b>		
	ASSY LCD MODULE 15.4 IN. WXGA SAMSUNG (LTN154X1-L02)	6M.A25V5.011
	LCD 15.4 IN. WXGA SAMSUNG (LTN154X1-L02)	LK.15406.001
<b>BOARD</b>		
	LCD INVERTER	19.A14V5.001
<b>CASE/COVER/BRACKET ASSEMBLY</b>		
	LCD PANEL WITH LOGO W/ANTENNA-METAL	60.A25V5.002
	LCD BEZEL	42.A14V5.008
	LCD BRACKET L	33.A14V5.006
	LCD BRACKET R	33.A14V5.007
<b>CABLE</b>		
	LCD COAXIAL CABLE 15.4 IN WXGA SAMSUNG	50.A24V5.004
<b>MISCELLANEOUS</b>		
	LCD RUBBER	47.A14V5.001
	LCD SCREW PAD	47.A14V5.002
<b>LCD LG MODULE</b>		
	ASSY LCD MODULE 15.4 IN. WXGA LG (LP154W01-A3)	6M.A25V5.012
	LCD 15.4 IN. WXGA LG (LP154W01-A3)	LK.15408.001
<b>BOARD</b>		
	LCD INVERTER	19.A14V5.001
<b>CASE/COVER/BRACKET ASSEMBLY</b>		
	LCD PANEL WITH LOGO W/ANTENNA-METAL	60.A25V5.002
	LCD BEZEL	42.A14V5.008
	LCD BRACKET L	33.A14V5.006
	LCD BRACKET R	33.A14V5.007
<b>CABLE</b>		
	LCD COAXIAL CABLE 15.4 IN. WXGA LG	50.A24V5.005
<b>MISCELLANEOUS</b>		
	LCD RUBBER	47.A14V5.001
	LCD SCREW PAD	47.A14V5.002
<b>LCD AU MODULE</b>		
	ASSY LCD MODULE 15.4 IN. WXGA AU (B154EW01)	6M.A25V5.013
	LCD 15.4 IN. WXGA AU (B154EW01)	LK.15401.001
<b>BOARD</b>		
	LCD INVERTER	19.A14V5.001
<b>CASE/COVER/BRACKET ASSEMBLY</b>		

PHOTO	PARTNAME	ACER P/N
	LCD PANEL WITH LOGO W/ANTENNA-METAL	60.A25V5.002
	LCD BEZEL	42.A14V5.008
	LCD BRACKET-L	33.A14V5.006
	LCD BRACKET-R	33.A14V5.007
<b>CABLE</b>		
	LCD COAXIAL CABLE 15.4IN. WXGA AU	50.A24V5.006
<b>MISCELLANEOUS</b>		
	LCD RUBBER	47.A14V5.001
	LCD SCREW PAD	47.A14V5.002
<b>MAINBOARD</b>		
	MAINBOARD 128MB W/PCMCIA SLOT W/O CPU MEMORY	LB.A2502.001
<b>CASE/COVER/BRACKET ASSEMBLY</b>		
	PCMCIA SLOT	22.A14V5.001
	PCMCIA DUMMY CARD	42.A14V5.009
<b>FAN</b>		
	FAN	23.A14V5.001
<b>HEATSINK</b>		
	THERMAL MODULE	60.A14V5.004
<b>POINTING DEVICE</b>		
	TOUCHPAD	56.A14V5.001
<b>READER</b>		
	4 IN 1 CARD READER BOARD	55.A25V5.005
<b>SPEAKER</b>		
	SPEAKER SET (R&L) - FORTUNE/VECO	6K.A14V5.001
	SUB-WOOFER	23.A25V5.001
<b>MISCELLANEOUS</b>		
	RUBBER FOOT	47.A14V5.003
<b>SCREW LIST</b>		
	SCREW, JIM M2.0X4	86.A14V5.001
	SCREW, JIM M2.5X4	86.A14V5.002
	SCREW, JIM M2.5X5	86.A14V5.003
	SCREW, JIM M2.5X10	86.A14V5.004
	SCREW, JIM M2.5X14	86.A14V5.005
	SCREW, JIM M3.0X3	86.A14V5.006
	SCREW, JIM M2.0X8 (Ni)	86.A14V5.007
	SCREW, JIM M2.0X6 (Ni)	86.A14V5.008
	SCREW, JACK SCREW	86.A14V5.009
	SCREW, SPEACIAL SCREW	86.A14V5.011

## Aspire 2020 Parts List

PHOTO	PARTNAME	ACER P/N
<b>ADAPTER</b>		
	ADAPTER W/LED-DELTA 65W ADP-65B	AP.T2101.001
	ADAPTER W/O LED-LITEON 65W PA-1650-02CR	AP.T3503.001
<b>BATTERY</b>		
	BATTERY LI-ION&CELLS-PANASONIC GC86503PAJ0	BT.A2401.002
	BATTERY LI-ION&CELLS-SAMSUNG- GC86508SMG0	BT.A2401.001
	BATTERY LI-ION&CELLS 2150mAH-PANASONIC	BT.A2401.003
<b>BOARD</b>		
	MODEM BOARD AMBIT T60M283	54.A14V5.001
	MINI PCI WIRELESS BOARD (802.11b)INTEL	54.A14V5.002
	MINI PCI WIRELESS BOARD (802.11 b+g)	54.A24V5.001
	LAUNCH BOARD	55.A24V5.001
	WIRELESS & B/T SWITCH BOARD	55.A14V5.003
	LED BOARD	55.A24V5.002
	T/P BOARD W/3*FFC	55.A24V5.003
	AUDIO CARD	55.A24V5.004
<b>CABLES</b>		
	CARD READER WIRE SET	50.A24V5.001
	MODEM CABLE	50.A24V5.002
	TOUCHPAD FFC CABLE	50.A24V5.003
	POWER CORD US	27.A14V5.001
	POWER CORD EC	27.A14V5.002
	POWER CORD AUS	27.A14V5.003
	POWER CORD UK	27.A14V5.004
	POWER CORD SWISS	27.A14V5.005
	POWER CORD CHINA	27.A14V5.006
	POWER CORD ITALIAN	27.A14V5.007
	POWER CORD DENMARK	27.A14V5.008
<b>CASE/COVER/BRACKET ASSEMBLY</b>		
	MIDDLE COVER W/NAME PLATE	42.A24V5.001
	LOWER CASE ASSY FOR 4 IN 1 READER	60.A24V5.001
	LOWER CASE ASSY NON 4 IN 1 READER	60.A24V5.002
	DIMM COVER	42.A24V5.002
	UPPER CASE ASSY W/O SPEAKER FAN HINGE SIDDLE FOR 4 IN 1 READER	60.A24V5.003
	UPPER CASE ASSY W/SPEAKER FAN HINGE SIDDLE NON 4 IN 1 READER	60.A24V5.004
	MINI PCI COVER	42.A24V5.003
	TOUCHPAD BRACKET	33.A24V5.001
	HINGE SADDLE -R	33.A14V5.008

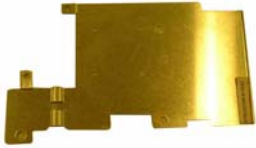
PHOTO	PARTNAME	ACER P/N
	HINGE SADDLE -L	33.A14V5.009
	VGA PLATE W/THURMAL PAD	33.A24V5.002
	VGA PLATE W/O THURMAL PAD	33.A24V5.003
	SUB-WOOFER CASE	60.A24V5.006
<b>COMMUNICATION MODULE</b>		
	ANTENNA ASSY	50.A14V5.006
<b>COMBO DRIVE</b>		
	DVD/CDRW COMBO MODULE QSI (TRAY IN)(242C)	6M.A24V5.001
	DVD/CDRW COMBO DRIVE HLDS (TRAY)(GCC4241N)	TBD
<b>CASE/COVER/BRACKET ASSEMBLY</b>		
	DVD/CDRW COMBO BEZEL FOR HLDS (TRAY)	42.A24V5.004
	OPTICAL DEVICE BRACKET	33.A14V5.004
<b>COMBO DRIVE</b>		
	DVD/CDRW COMBO MODULE QSI (TRAY IN)(242C)	6M.A24V5.002
	DVD/CDRW COMBO DRIVE QSI(TRAY IN)(242C)	TBD
<b>CASE/COVER/BRACKET ASSEMBLY</b>		
	DVD/CDRW COMBO BEZEL FOR QSI (TRAY IN)(242C)	42.A24V5.005
	OPTICAL DEVICE BRACKET	33.A14V5.004
<b>COMBO DRIVE</b>		
	DVD/CDRW COMBO MODULE KME (TRAY IN)(UJDA750)	6M.A24V5.003
	DVD/CDRW COMBO DRIVE KME (TRAY IN)(UJDA 750)	TBD
<b>CASE/COVER/BRACKET ASSEMBLY</b>		
	DVD/CDRW COMBO BEZEL FRO KME (TRAY IN)(UJDA750)	42.A24V5.006
	OPTICAL DEVICE BRACKET	33.A14V5.004
<b>DVD RW DRIVE</b>		
	DVD SUPER MULTI MODULE KME (TRAY IN)(UJ820B)	6M.A24V5.005
	DVD SUPER MULTI DRIVE KME (TRAY IN)(UJ820B)	TBD
<b>CASE/COVER/BRACKET ASSEMBLY</b>		
	DVD SUPER MULTI BEZEL FOR KME (TRAY IN)(UJ820B)	42.A24V5.008
	OPTICAL DEVICE BRACKET	33.A14V5.004
	HDD CARRIER	42.A14V5.007
	HDD CONNECTOR	20.A14V5.001
<b>KEYBOARD</b>		
	KEYBOARD ARABIC	KB.A2405.011
	KEYBOARD BELGIUM	KB.A2405.013
	KEYBOARD CHINESE	KB.A2405.005

PHOTO	PARTNAME	ACER P/N
	KEYBOARD CZECH	KB.A2405.015
	KEYBOARD DANISH	KB.A2405.018
	KEYBOARD FRENCH	KB.A2405.006
	KEYBOARD GERMAN	KB.A2405.003
	KEYBOARD ITALIAN	KB.A2405.004
	KEYBOARD NORWEGIAN	KB.A2405.017
	KEYBOARD PORTUGUESE	KB.A2405.010
	KEYBOARD SPANISH	KB.A2405.009
	KEYBOARD SWEDEN	KB.A2405.014
	KEYBOARD SWISS/G	KB.A2405.008
	KEYBOARD THAI	KB.A2405.012
	KEYBOARD UK	KB.A2405.002
	KEYBOARD US INTERNATIONAL	KB.A2405.001
	KEYBOARD HUNGAIAN	KB.A2405.016
	KEYBOARD CANADIAN FRENCH	KB.A2405.007
	KEYBOARD RUSSIAN	KB.A2405.019
<b>LCD</b>		
	ASSY LCD MODULE 15.4 IN. WXGA SAMSUNG (LTN154X1-L02)	6M.A24V5.011
	LCD 15.4 IN. WXGA SAMSUNG (LTN154X1-L02)	LK.15406.001
	ASSY LCD MODULE 15.4 IN. WXGA LG (LP154W01-A3)	6M.A24V5.012
	LCD 15.4 IN. WXGA LG (LP154W01-A3)	LK.15408.001
	ASSY LCD MODULE 15.4 IN. WXGA (B154EW01)	6M.A24V5.013
	LCD 15.4 IN WXGA AU (B154EW01)	LK.15401.001
<b>BOARD</b>		
	LCD INVERTER	19.A14V5.001
<b>CASE/COVER/BRACKET ASSMEBLY</b>		
	LCD PANEL WITH LOGO W/ANTENNA-PLASTIC	60.A24V5.005
	LCD BEZEL	42.A14V5.008
	LCD BRACKET L	33.A14V5.006
	LCD BRACKET R	33.A14V5.007
	PCMCIA SLOT	22.A14V5.001
	PCMCIA DUMMY CARD	42.A14V5.009
<b>CABLE</b>		
	LCD COAXIAL CABLE 15.4 IN. WXGA SAMSUNG	50.A24V5.004
	LCD COAXIAL CABLE 15.4 IN. WXGA LG	50.A24V5.005
	LCD COAXIAL CABLE 15.4 IN. WXGA AU	50.A24V5.006
<b>MISCELLANEOUS</b>		
	LCD RUBBER	47.A14V5.001
	LCD SCREW PAD	47.A14V5.002
	RUBBER FOOT	47.A14V5.003

PHOTO	PARTNAME	ACER P/N
	MAINBOARD DISCRETE 64MB W/PCMCIA SLOT W/O CPU MEMORY	LB.A2402.001
	MAINBOARD UMA W/PCMCIA SLOT W/O CPU MEMORY	LB.A2402.002
<b>FAN</b>		
	FAN	23.A14V5.001
<b>HEATSINK</b>		
	THERMAL MODULE	60.A14V5.004
<b>POINTING DEVICE</b>		
	TOUCHPAD	56.A14V5.001
<b>READER</b>		
	4 IN 1 CARD READER BOARD	55.A14V5.006
<b>SPEAKER</b>		
	SPEAKER SET (R&L) FORTUNE/ECO	6K.A14V5.001
<b>SCREWS</b>		
	SCREW, JIM M2.0X4	86.A14V5.001
	SCREW, JIM M2.5X4	86.A14V5.002
	SCREW, JIM M2.5X5	86.A14V5.003
	SCREW, JIM M2.5X10	86.A14V5.004
	SCREW, JIM M2.5X14	86.A14V5.005
	SCREW, JIM M3.0X3	86.A14V5.006
	SCREW, JIM M2.0X8 (Ni)	86.A14V5.007
	SCREW, JIM M2.0X6 (Ni)	86.A14V5.008
	SCREW, JACK SCREW	86.A14V5.009
	SCREW, SPEACIAL SCREW	86.A14V5.011

# *Model Definition and Configuration*

## **Aspire 2010/2020 series**

<b>Model Number</b>	<b>CPU</b>	<b>LCD</b>	<b>Memory</b>	<b>HDD</b>	<b>Optical</b>	<b>Mini PCI</b>	<b>Card Reader</b>	<b>Battery</b>
2012WLCi	PM 1.5GH z/1M	15.4" WXGA	DDR333 1x256M B	40GB	24x Combo	802.11b/g- AS2010	N/A	Li-Ion- AS201 0
2012WLMi	PM 1.5GH z/1M	15.4" WXGA	DDR333 2x256M B	40/ 60GB	4x DVD- Dual	802.11b/g- AS2010	4 in 1- AS2010	Li-Ion- AS201 0
2025WLMi	PM 1.8GH z/2M	15.4" WXGA	DDR333 2x256M B	60/ 80GB	Slot 4x DVD- SMulti	802.11b/g- AS2020	4 in 1- AS2020	Li-Ion- AS202 0



# *Test Compatible Components*

---

This computer's compatibility is tested and verified by Acer's internal testing department. All of its system functions are tested under Windows XP Home and Windows XP Professional environment.

Refer to the following lists for components, adapter cards, and peripherals which have passed these tests.

Regarding configuration, combination and test procedures, please refer to the *Aspire 2010/2020 Compatibility Test*. Report released by the Acer Mobile System Testing Department.

## Microsoft Windows XP Home Environment Test

	Description	Model Number	Acer P/N
CPU	Intel Pentium-M (Banias) 1.4GHz 1M/400MHz FSB		KC.BS001.14G
	Intel Pentium-M (Banias) 1.5GHz 1M/400MHz FSB		KC.BS001.15G
	Intel Pentium-M (Banias) 1.6GHz 1M/400MHz FSB		KC.BS001.16G
	Intel Pentium-M (Banias) 1.7GHz 1M/400MHz FSB		KC.BS001.17G
	Intel Pentium-M (Dothan) 1.6GHz 2M/400MHz FSB		TBD
	Intel Pentium-M (Dothan) 1.7GHz 2M/400MHz FSB		KC.ND001.17G
	Intel Pentium-M (Dothan) 1.8GHz 2M/400MHz FSB		KC.ND001.18G
HDD	HDD 2.5" HGST Moraga IC25N030ATMR04-0 08K0910 30G 4200PRM	08K0910	KH.03007.005
	HDD 2.5" Toshiba Pluto MK4025GAS 40GB 4200PRM	MK4025GAS	KH.04004.002
	HDD 2.5" HGST Moraga IC25N040ATMR04-0 08K0633 40G 4200PRM (F/W:AD4A)	08K0633	KH.04007.009
	HDD 2.5" Seagate N1 ST94019A 2MB 40GB 4200PRM (F/W:3.05)	ST94019A	KH.04001.010
	HDD 2.5" HGST Moraga IC25N060ATMR04-0 08K0634 60G 4200RPM(F/W:AD4A)	08K0634	KH.06007.006
	HDD 2.5" Toshiba Pluto MK6025GAS 60GB 4200RPM		KH.06004.003
	HDD 2.5" HGST Moraga HTS548060M9AT00 08K0638 60G 5400RPM	08K0638	KH.06007.002
	HDD 2.5" HGST Moraga IC25N080ATCS04-0 08K0635 80G 4200RPM	08K0635	KH.08007.007
	HDD 2.5" HGST Moraga HTS548080M9AT00 08K0639 80G 5400rpm	08K0639	KH.08007.003
LCD Panel	Samsung 15.4" WXGA (1280 x 800) TFT Panel	LTN154X1-L02	LK.15406.003
	LG 15.4" WXGA (1280 x 800) TFT Panel.	LP154W01-A3	LK.15408.001
	AU 15.4" WXGA (1280 x 800) TFT Panel	B154EW01	LK.15405.001
	Sanyo 15.4" WXGA (1280 x 800) TFT Panel	TM154WX-22L31	LK.1540J.001
	QDI 15.4" WXGA (1280 x 800) TFT Panel	QD15TL02-01	LK.15409.001
	LG 15.4" WSXGA+ (1600 x 1050) TFT Panel	LP154W02-A1	LK.15408.002
	LG 15.4" WSXGA+ (1600 x 1050) TFT Panel	LP154W02-B1	LK.15408.003
Chipset	Intel 855GME		
	Intel ICH4-M		KI.80101.005

	Description	Model Number	Acer P/N
Optical Drive	QSI 12.7mm Tray Type DVD/CDRW combo 24/24/24,8X	SBW-242C (for Drongo3/4)	KO.02407.013
	Pnasonic 12.7mm tray Type DVD/CDRW combo 24/24/24,8X	UJDA750-II (for Drongo3/4)	KO.02406.004
	HLDS 12.7mm Tray Type DVD/CDRW combo 24/24/24,8X	GCC-4241N (for Drongo3/4)	KO.02405.001
	QSI 12.7mm Tray Type DVD-Dual	SDW-042 (for Drongo3/4)	KU.00403.002
	HLDS 12.7mm Tray Type DVD-Dual	GSA-4040N (for Drongo3/4)	KU.0040D.004
	Pnasonic 12.7mm Tray Type Super Multi	UJ820B (for Drongo3/4)	KU.00407.003
	Pnasonic 12.7mm Slot-in DVD/CDRW combo	CW-8123 (for Drongo2)	KO.02406.005
	Pnasonic 12.7mm Slot-in Super Multi	UJ-825 (for Drongo2)	KU.00407.004
Memory	Infineon SO-DIMM DDR333 256MB HYS64D32020GDL-6-B 16x16x8 (0.14u)		KN.25602.009
	Infineon SO-DIMM DDR333 512MB HYS64D64020GBDL-6-C 64Mx64 (0.11u/black)		KN.51202.013
	Nanya SO-DIMM DDR333 256MB NT256D64SH8BAGM-6KE (.14u)		KN.25603.014
	Nanya SO-DIMM DDR333 512MB NT512D64S8HBAFM-6K (.14u)		KN.51203.005
	Micron SO-DIMM DDR333 256MB MT8VDDT3264HDG-335C3 (.13u)		KN.25604.009
	Micron SO-DIMM DDR333 256MB MT8VDDT3264H G-335G3 (0.11u)		KN.25604.014
	Micron SO-DIMM DDR 333 512MB MT16VDDF6464H G-335G2 (0.11u)		KN.51204.012
Wireless LAN	Intel Wireless LAN, MiniPCI Type 3B Intel 802.11b		KI.CAX01.007
	Intel Wireless LAN, MiniPCI Type 3B Intel 802.11b/g		
Battery	AS2010 BATCL32CL 8Cell (Samsung)		BT.A2401.001
	AS2010 BATCL32CL 8Cell (Panasonic)		BT.A2401.002
	AS2010 BATCL32L4 4Cell (Panasonic)		BT.A2401.003
	AS2020 BAT CL32CL 8CELL (Samsung)		BT.A2501.001
	AS2020 BAT CL32CL 8CELL (Panasonic)		BT.A2501.002
Mainboard	AS2010 Discrete Mainboard		LB.A2402.001
	AS2020 Mainboard		LB.A2502.001
Adapter	Delta ADP-65DB 3P 65W		AP.T2101.001
	Lite-on PA-1650-02CA 3P 65W ABO		AP.T3503.001
	Lite-on PA-1650-02CR 3P 65W 19V ABO		AP.06503.002
	Delta ADP-65DB 3P 65W w/US Power Cord		AP.A1401.002
	Lite-on PA-1650-02CA 3P 65W ABO w/US Power Cord		AP.T3503.002

	Description	Model Number	Acer P/N
Keyboard	AS2010 (ZIPPY) KEYBOARD US International		KB.A240C.001
	AS2010 (ZIPPY) KEYBOARD UK		KB.A240C.002
	AS2010 (ZIPPY) KEYBOARD German		KB.A240C.003
	AS2010 (ZIPPY) KEYBOARD Italian		KB.A240C.004
	AS2010 (ZIPPY) KEYBOARD Chinese		KB.A240C.005
	AS2010 (ZIPPY) KEYBOARD French		KB.A240C.006
	AS2010 (ZIPPY) KEYBOARD Canadian French		KB.A240C.007
	AS2010 (ZIPPY) KEYBOARD Swiss/G		KB.A240C.008
	AS2010 (ZIPPY) KEYBOARD Spanish		KB.A240C.009
	AS2010 (ZIPPY) KEYBOARD Portuguese		KB.A240C.010
	AS2010 (ZIPPY) KEYBOARD Arabic		KB.A240C.011
	AS2010 (ZIPPY) KEYBOARD Thai		KB.A240C.012
	AS2010 (ZIPPY) KEYBOARD Belgium		KB.A240C.013
	AS2010 (ZIPPY) KEYBOARD Sweden		KB.A240C.014
	AS2010 (ZIPPY) KEYBOARD Czech		KB.A240C.015
	AS2010 (ZIPPY) KEYBOARD Hungaian		KB.A240C.016
	AS2010 (ZIPPY) KEYBOARD Norway		KB.A240C.017
	AS2010 (ZIPPY) KEYBOARD Danish		KB.A240C.018
	AS2010 (ZIPPY) KEYBOARD Russian		KB.A240C.019
	AS2010 (JingMold) Keyboard US International		KB.A2405.001
	AS2010 (JingMold) Keyboard UK		KB.A2405.002
	AS2010 (JingMold) Keyboard German		KB.A2405.003
	AS2010 (JingMold) Keyboard Italian		KB.A2405.004
	AS2010 (JingMold) Keyboard Chinese		KB.A2405.005
	AS2010 (JingMold) Keyboard French		KB.A2405.006
	AS2010(JingMold) Keyboard Canadian French		KB.A2405.007
	AS2010 (JingMold) Keyboard Swiss/G		KB.A2405.008
	AS2010 (JingMold) Keyboard Spanish		KB.A2405.009
	AS2010 (JingMold) Keyboard Portuguese		KB.A2405.010
	AS2010 (JingMold) Keyboard Arabic		KB.A2405.011
	AS2010 (JingMold) Keyboard Thai		KB.A2405.012
	AS2010 (JingMold) Keyboard Belgium		KB.A2405.013
	AS2010 (JingMold) Keyboard Sweden		KB.A2405.014
	AS2010 (JingMold) Keyboard Czech		KB.A2405.015
	AS2010 (JingMold) Keyboard Hungaian		KB.A2405.016
	AS2010 (JingMold) Keyboard Norway		KB.A2405.017
AS2010 (JingMold) Keyboard Danish		KB.A2405.018	
AS2010 (JingMold) Keyboard Russian		KB.A2405.019	

## Microsoft Windows XP Professional Environment Test

	Description	Model Number	Acer P/N
CPU	Intel Pentium-M (Banias) 1.4GHz 1M/400MHz FSB		KC.BS001.14G
	Intel Pentium-M (Banias) 1.5GHz 1M/400MHz FSB		KC.BS001.15G
	Intel Pentium-M (Banias) 1.6GHz 1M/400MHz FSB		KC.BS001.16G
	Intel Pentium-M (Banias) 1.7GHz 1M/400MHz FSB		KC.BS001.17G
	Intel Pentium-M (Dothan) 1.6GHz 2M/400MHz FSB		TBD
	Intel Pentium-M (Dothan) 1.7GHz 2M/400MHz FSB		KC.ND001.17G
	Intel Pentium-M (Dothan) 1.8GHz 2M/400MHz FSB		KC.ND001.18G
HDD	HDD 2.5" HGST Moraga IC25N030ATMR04-0 08K0910 30G 4200PRM	08K0910	KH.03007.005
	HDD 2.5" Toshiba Pluto MK4025GAS 40GB 4200PRM	MK4025GAS	KH.04004.002
	HDD 2.5" HGST Moraga IC25N040ATMR04-0 08K0633 40G 4200PRM (F/W:AD4A)	08K0633	KH.04007.009
	HDD 2.5" Seagate N1 ST94019A 2MB 40GB 4200PRM (F/W:3.05)	ST94019A	KH.04001.010
	HDD 2.5" HGST Moraga IC25N060ATMR04-0 08K0634 60G 4200RPM(F/W:AD4A)	08K0634	KH.06007.006
	HDD 2.5" Toshiba Pluto MK6025GAS 60GB 4200RPM		KH.06004.003
	HDD 2.5" HGST Moraga HTS548060M9AT00 08K0638 60G 5400RPM	08K0638	KH.06007.002
	HDD 2.5" HGST Moraga IC25N080ATCS04-0 08K0635 80G 4200RPM	08K0635	KH.08007.007
	HDD 2.5" HGST Moraga HTS548080M9AT00 08K0639 80G 5400rpm	08K0639	KH.08007.003
LCD Panel	Samsung 15.4" WXGA (1280 x 800) TFT Panel	LTN154X1-L02	LK.15406.003
	LG 15.4" WXGA (1280 x 800) TFT Panel.	LP154W01-A3	LK.15408.001
	AU 15.4" WXGA (1280 x 800) TFT Panel	B154EW01	LK.15405.001
	Sanyo 15.4" WXGA (1280 x 800) TFT Panel	TM154WX- 22L31	LK.1540J.001
	QDI 15.4" WXGA (1280 x 800) TFT Panel	QD15TL02-01	LK.15409.001
	LG 15.4" WSXGA+ (1600 x 1050) TFT Panel	LP154W02-A1	LK.15408.002
	LG 15.4" WSXGA+ (1600 x 1050) TFT Panel	LP154W02-B1	LK.15408.003
Chipset	Intel 855GME		
	Intel ICH4-M		KI.80101.005

	Description	Model Number	Acer P/N
Optical Drive	QSI 12.7mm Tray Type DVD/CDRW combo 24/24/24,8X	SBW-242C (for Drongo3/4)	KO.02407.013
	Pnasonic 12.7mm tray Type DVD/CDRW combo 24/24/24,8X	UJDA750-II (for Drongo3/4)	KO.02406.004
	HLDS 12.7mm Tray Type DVD/CDRW combo 24/24/24,8X	GCC-4241N (for Drongo3/4)	KO.02405.001
	QSI 12.7mm Tray Type DVD-Dual	SDW-042 (for Drongo3/4)	KU.00403.002
	HLDS 12.7mm Tray Type DVD-Dual	GSA-4040N (for Drongo3/4)	KU.0040D.004
	Pnasonic 12.7mm Tray Type Super Multi	UJ820B (for Drongo3/4)	KU.00407.003
	Pnasonic 12.7mm Slot-in DVD/CDRW combo	CW-8123 (for Drongo2)	KO.02406.005
	Pnasonic 12.7mm Slot-in Super Multi	UJ-825 (for Drongo2)	KU.00407.004
Memory	Infineon SO-DIMM DDR333 256MB HYS64D32020GDL-6-B 16x16x8 (0.14u)		KN.25602.009
	Infineon SO-DIMM DDR333 512MB HYS64D64020GBDL-6-C 64Mx64 (0.11u/black)		KN.51202.013
	Nanya SO-DIMM DDR333 256MB NT256D64S8BAGM-6KE (.14u)		KN.25603.014
	Nanya SO-DIMM DDR333 512MB NT512D64S8HBAFM-6K (.14u)		KN.51203.005
	Micron SO-DIMM DDR333 256MB MT8VDDT3264HDG-335C3 (.13u)		KN.25604.009
	Micron SO-DIMM DDR333 256MB MT8VDDT3264H G-335G3 (0.11u)		KN.25604.014
	Micron SO-DIMM DDR 333 512MB MT16VDDF6464H G-335G2 (0.11u)		KN.51204.012
Wireless LAN	Intel Wireless LAN, MiniPCI Type 3B Intel 802.11b		KI.CAX01.007
	Intel Wireless LAN, MiniPCI Type 3B Intel 802.11b/g		
Battery	AS2010 BATCL32CL 8Cell (Samsung)		BT.A2401.001
	AS2010 BATCL32CL 8Cell (Panasonic)		BT.A2401.002
	AS2010 BATCL32L4 4Cell (Panasonic)		BT.A2401.003
	AS2020 BAT CL32CL 8CELL (Samsung)		BT.A2501.001
	AS2020 BAT CL32CL 8CELL (Panasonic)		BT.A2501.002
Mainboard	AS2010 Discrete Mainboard		LB.A2402.001
	AS2020 Mainboard		LB.A2502.001
Adapter	Delta ADP-65DB 3P 65W		AP.T2101.001
	Lite-on PA-1650-02CA 3P 65W ABO		AP.T3503.001
	Lite-on PA-1650-02CR 3P 65W 19V ABO		AP.06503.002
	Delta ADP-65DB 3P 65W w/US Power Cord		AP.A1401.002
	Lite-on PA-1650-02CA 3P 65W ABO w/US Power Cord		AP.T3503.002

	Description	Model Number	Acer P/N
Keyboard	AS2010 (ZIPPY) KEYBOARD US International		KB.A240C.001
	AS2010 (ZIPPY) KEYBOARD UK		KB.A240C.002
	AS2010 (ZIPPY) KEYBOARD German		KB.A240C.003
	AS2010 (ZIPPY) KEYBOARD Italian		KB.A240C.004
	AS2010 (ZIPPY) KEYBOARD Chinese		KB.A240C.005
	AS2010 (ZIPPY) KEYBOARD French		KB.A240C.006
	AS2010 (ZIPPY) KEYBOARD Canadian French		KB.A240C.007
	AS2010 (ZIPPY) KEYBOARD Swiss/G		KB.A240C.008
	AS2010 (ZIPPY) KEYBOARD Spanish		KB.A240C.009
	AS2010 (ZIPPY) KEYBOARD Portuguese		KB.A240C.010
	AS2010 (ZIPPY) KEYBOARD Arabic		KB.A240C.011
	AS2010 (ZIPPY) KEYBOARD Thai		KB.A240C.012
	AS2010 (ZIPPY) KEYBOARD Belgium		KB.A240C.013
	AS2010 (ZIPPY) KEYBOARD Sweden		KB.A240C.014
	AS2010 (ZIPPY) KEYBOARD Czech		KB.A240C.015
	AS2010 (ZIPPY) KEYBOARD Hungaian		KB.A240C.016
	AS2010 (ZIPPY) KEYBOARD Norway		KB.A240C.017
	AS2010 (ZIPPY) KEYBOARD Danish		KB.A240C.018
	AS2010 (ZIPPY) KEYBOARD Russian		KB.A240C.019
	AS2010 (JingMold) Keyboard US International		KB.A2405.001
	AS2010 (JingMold) Keyboard UK		KB.A2405.002
	AS2010 (JingMold) Keyboard German		KB.A2405.003
	AS2010 (JingMold) Keyboard Italian		KB.A2405.004
	AS2010 (JingMold) Keyboard Chinese		KB.A2405.005
	AS2010 (JingMold) Keyboard French		KB.A2405.006
	AS2010(JingMold) Keyboard Canadian French		KB.A2405.007
	AS2010 (JingMold) Keyboard Swiss/G		KB.A2405.008
	AS2010 (JingMold) Keyboard Spanish		KB.A2405.009
	AS2010 (JingMold) Keyboard Portuguese		KB.A2405.010
	AS2010 (JingMold) Keyboard Arabic		KB.A2405.011
	AS2010 (JingMold) Keyboard Thai		KB.A2405.012
	AS2010 (JingMold) Keyboard Belgium		KB.A2405.013
	AS2010 (JingMold) Keyboard Sweden		KB.A2405.014
	AS2010 (JingMold) Keyboard Czech		KB.A2405.015
	AS2010 (JingMold) Keyboard Hungaian		KB.A2405.016
	AS2010 (JingMold) Keyboard Norway		KB.A2405.017
AS2010 (JingMold) Keyboard Danish		KB.A2405.018	
AS2010 (JingMold) Keyboard Russian		KB.A2405.019	

# Online Support Information

---

This section describes online technical support services available to help you repair your Acer Systems. If you are a distributor, dealer, ASP or TPM, please refer your technical queries to your local Acer branch office. Acer Branch Offices and Regional Business Units may access our website. However some information sources will require a user i.d. and password. These can be obtained directly from Acer CSD Taiwan.

Acer's Website offers you convenient and valuable support resources whenever you need them.

In the Technical Information section you can download information on all of Acer's Notebook, Desktop and Server models including:

- Service guides for all models
- User's manuals
- Training materials
- Bios updates
- Software utilities
- Spare parts lists
- TABs (Technical Announcement Bulletin)

For these purposes, we have included an Acrobat File to facilitate the problem-free downloading of our technical material.

Also contained on this website are:

- Detailed information on Acer's International Traveler's Warranty (ITW)
- An overview of all the support services we offer, accompanied by a list of telephone, fax and email contacts for all your technical queries.

We are always looking for ways to optimize and improve our services, so if you have any suggestions or comments, please do not hesitate to communicate these to us.